

EE 330

Lecture 19

Bipolar Device Operation and Modeling

Exam Schedule

Exam 2 will be given on Friday March 11

Exam 3 will be given on Friday April 15

Photo courtesy of the director of the National Institute of Health (NIH)



As a courtesy to fellow classmates, TAs, and the instructor

Wearing of masks during lectures and in the laboratories for this course would be appreciated irrespective of vaccination status

Review from last lecture

TABLE 2B.1
Process scenario of major process steps in typical n-well CMOS process^a

1.	Clean wafer	
2.	GROW THIN OXIDE	
3.	Apply photoresist	
4.	PATTERN n-well	(MASK #1)
5.	Develop photoresist	
6.	Deposit and diffus n-type impurities	
7.	Strip photoresist	
8.	Strip thin oxide	
9.	Grow thin oxide	
10.	Apply layer of Si ₃ N ₄	
11.	Apply photoresist	
12.	PATTERN Si ₃ N ₄ (active area definition)	(MASK #2)
13.	Develop photoresist	
14.	Etch Si ₃ N ₄	
15.	Strip photoresist	
	<i>Optional field threshold voltage adjust</i>	
	A.1 Apply photoresist	
	A.2 PATTERN ANTIMOAT IN SUBSTRATE	(MASK #A1)
	A.3 Develop photoresist	
	A.4 FIELD IMPLANT (p-type)	
	A.5 Strip photoresist	
16.	GROW FIELD OXIDE	
17.	Strip Si ₃ N ₄	
18.	Strip thin oxide	
19.	GROW GATE OXIDE	
20.	POLYSILICON DEPOSITION (POLY I)	
21.	Apply photoresist	
22.	PATTERN POLYSILICON	(MASK #3)
23.	Develop photoresist	
24.	ETCH POLYSILICON	

Review from last lecture

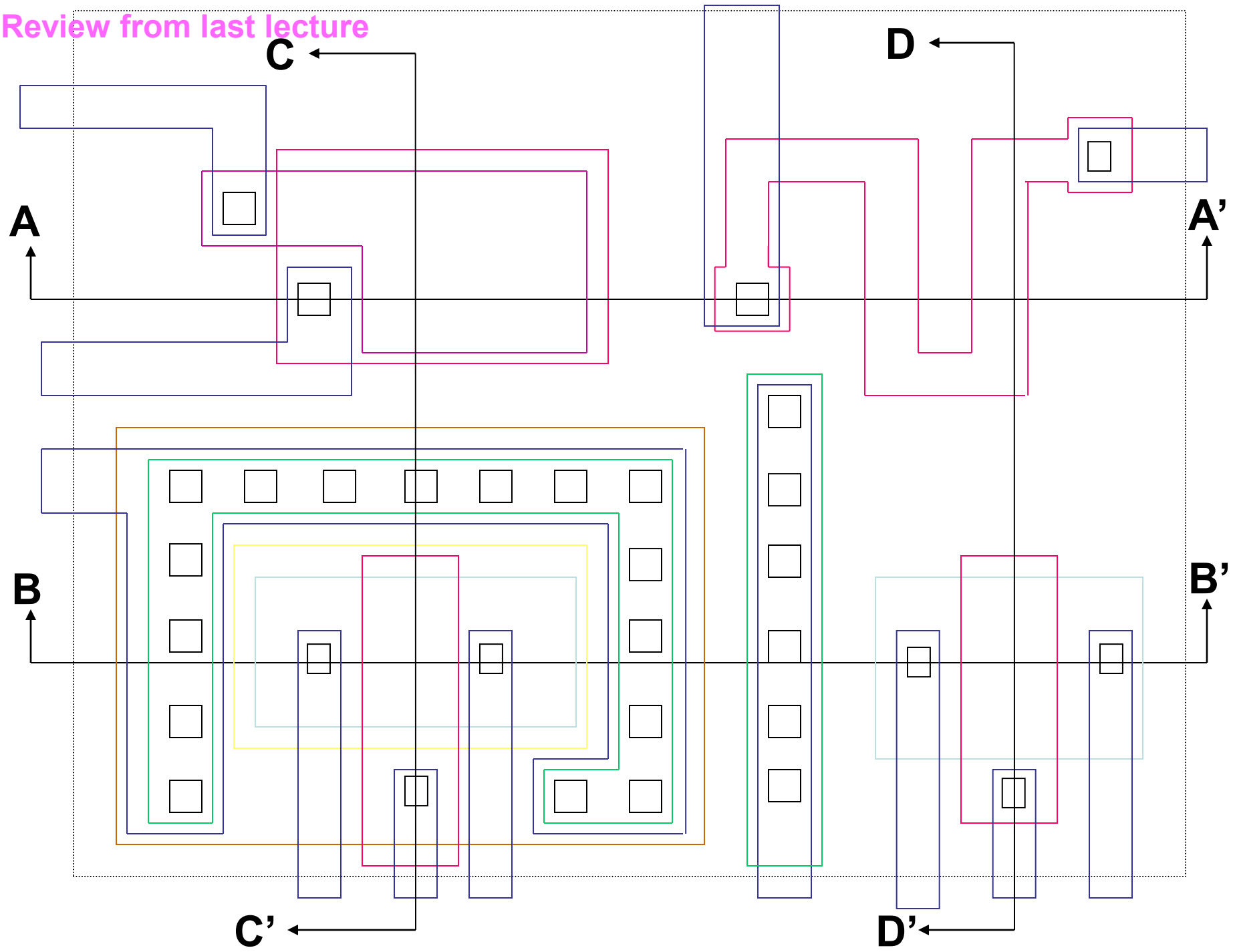

Review from last lecture

Metal Mask

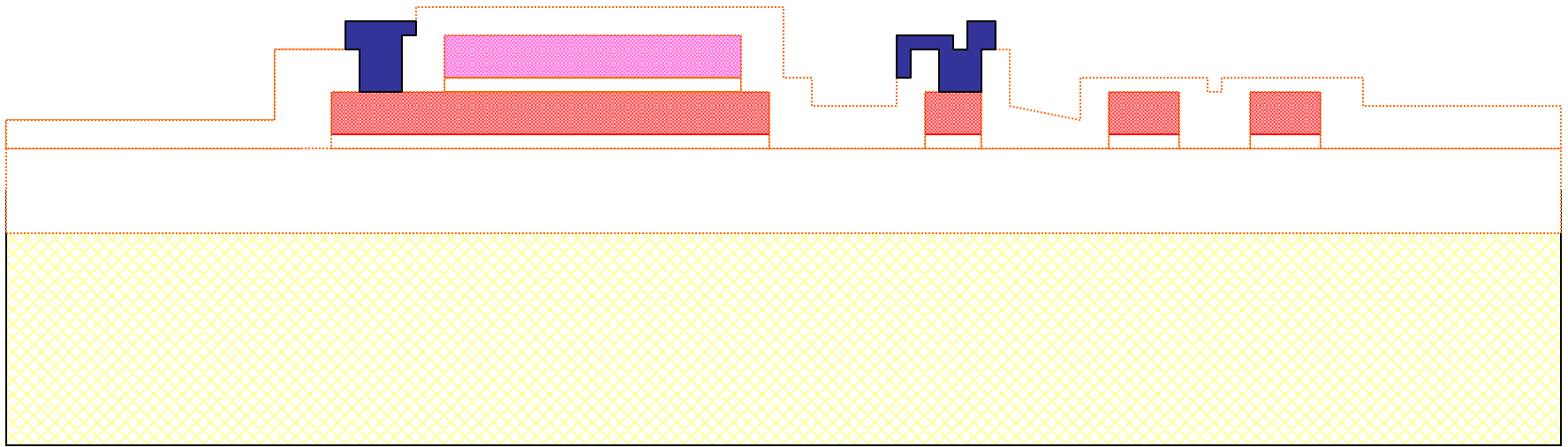

A-A' Section

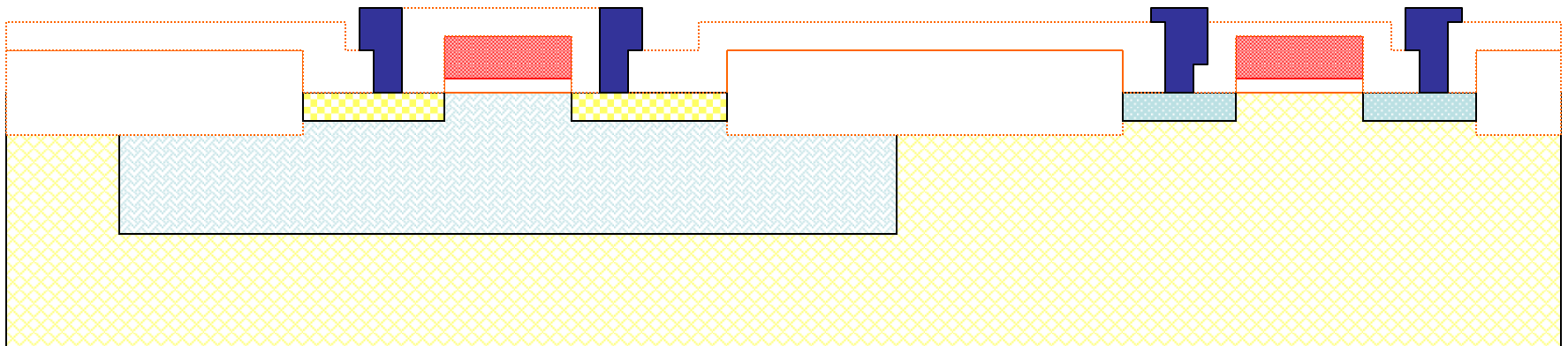

B-B' Section

Should now know what you can do in this process !!

Can metal connect to active?

Can metal connect to substrate when on top of field oxide?

How can metal be connected to substrate?

Can poly be connected to active under gate?

Can poly be connected to active any place?

Can metal be placed under poly to isolate it from bulk?

Can metal 2 be connected directly to active?

Can metal 2 be connected to metal 1?

Can metal 2 pass under metal 1?

Could a process be created that will result in an answer of YES to most of above?

How does the inverter delay compare between a 0.5u process and a 0.18u process?

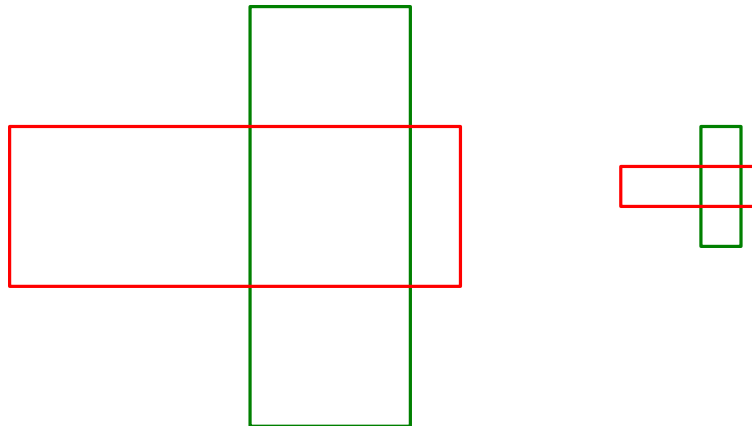
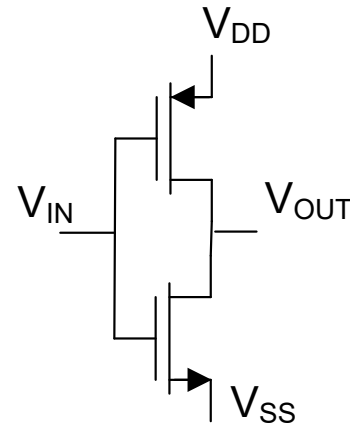
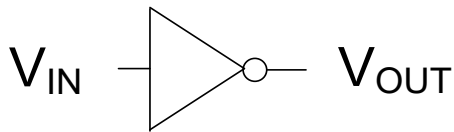

RUN: T91T
TECHNOLOGY: SCN05

VENDOR: AMIS
FEATURE SIZE: 0.5 microns

Run type: SKD

INTRODUCTION: This report contains the lot average results obtained by MOSIS from measurements of MOSIS test structures on each wafer of this fabrication lot. SPICE parameters obtained from similar measurements on a selected wafer are also attached.

COMMENTS: American Microsystems, Inc. C5

TRANSISTOR PARAMETERS	W/L	N-CHANNEL	P-CHANNEL	UNITS
MINIMUM Vth	3.0/0.6	0.81	-0.92	volts
SHORT Idss	20.0/0.6	466	-250	uA/um
Vth		0.69	-0.89	volts
Vpt		12.7	-11.7	volts
WIDE Ids0	20.0/0.6	< 2.5	< 2.5	pA/um
LARGE Vth	20.0/20.0	0.71	-0.94	volts
Vjbkd		8.8	-11.7	volts
Ijlk		<50.0	<50.0	pA
Gamma		0.44	0.57	V^0.5
K' (Uo*Cox/2)		54.8	-19.7	uA/V^2
Low-field Mobility		434.84	156.32	cm^2/V*s

PROCESS PARAMETERS	N+	P+	POLY	PLY2 HR	M1	UNITS
Sheet Resistance	85.3	111.2	22.4	1033	0.09	ohms/sq
Contact Resistance	59.6	145.4	17.9			ohms
Gate Oxide Thickness	137					angstroms

CAPACITANCE PARAMETERS	N+	P+	POLY	POLY2	M1	UNITS
Area (substrate)	443	745	102			aF/um ²
Area (N+active)			2518			aF/um ²
Area (P+active)			2441			aF/um ²
Area (poly)				896	61	aF/um ²

CIRCUIT PARAMETERS	UNITS
Ring Oscillator Freq.	
DIV256 (31-stg, 5.0V)	94.47 MHz
Ring Oscillator Power	
DIV256 (31-stg, 5.0V)	0.48 uW/MHz/gate

MOSIS WAFER ACCEPTANCE TESTS

RUN: T4BK (MM_NON-EPI_THK-MTL)
 TECHNOLOGY: SCN018

VENDOR: TSMC
 FEATURE SIZE: 0.18 microns

INTRODUCTION: This report contains the lot average results obtained by MOSIS from measurements of MOSIS test structures on each wafer of this fabrication lot. SPICE parameters obtained from similar measurements on a selected wafer are also attached.

COMMENTS: DSCN6M018_TSMC

TRANSISTOR PARAMETERS	W/L	N-CHANNEL	P-CHANNEL	UNITS
MINIMUM Vth	0.27/0.18	0.50	-0.53	volts
SHORT Idss	20.0/0.18	571	-266	uA/um
Vth		0.51	-0.53	volts
Vpt		4.7	-5.5	volts
WIDE Ids0	20.0/0.18	22.0	-5.6	pA/um
LARGE Vth	50/50	0.42	-0.41	volts
Vjbkd		3.1	-4.1	volts
Ijlk		<50.0	<50.0	pA
K' (Uo*Cox/2)		171.8	-36.3	uA/V^2
Low-field Mobility		398.02	84.10	cm^2/V*s

CAPACITANCE PARAMETERS	N+	P+	POLY	M1	M2	M3	M4	M5	M6	R_W	D_N_W	M5P	N_W	UNITS
Area (substrate)	998	1152	103	39	19	13	9	8	3		129		127	aF/um ²
Area (N+active)			8566	54	21	14	11	10	9					aF/um ²
Area (P+active)			8324											aF/um ²
Area (poly)				64	18	10	7	6	5					aF/um ²
Area (metal1)					44	16	10	7	5					aF/um ²
Area (metal2)						38	15	9	7					aF/um ²
Area (metal3)							40	15	9					aF/um ²
Area (metal4)								37	14					aF/um ²
Area (metal5)									36			1003		aF/um ²
Area (r well)	987													aF/um ²
Area (d well)										574				aF/um ²
Area (no well)	139													aF/um ²
Fringe (substrate)	244	201		18	61	55	43	25						aF/um
Fringe (poly)				69	39	29	24	21	19					aF/um
Fringe (metal1)					61	35		23	21					aF/um
Fringe (metal2)						54	37	27	24					aF/um
Fringe (metal3)							56	34	31					aF/um
Fringe (metal4)								58	40					aF/um
Fringe (metal5)									61					aF/um
Overlap (P+active)			652											aF/um

CIRCUIT PARAMETERS			UNITS
Inverters	K		
Vinv	1.0	0.74	volts
Vinv	1.5	0.78	volts
Vol (100 uA)	2.0	0.08	volts
Voh (100 uA)	2.0	1.63	volts
Vinv	2.0	0.82	volts
Gain	2.0	-23.33	
Ring Oscillator Freq.			
D1024_THK (31-stg, 3.3V)		338.22	MHz
DIV1024 (31-stg, 1.8V)		402.84	MHz
Ring Oscillator Power			
D1024_THK (31-stg, 3.3V)		0.07	uW/MHz/gate
DIV1024 (31-stg, 1.8V)		0.02	uW/MHz/gate

How does the inverter delay compare between a 0.5u process and a 0.18u process?

Feature	0.5	0.18	Units
Vtn	0.81	0.5	V
Vtp	-0.92	-0.53	V
uCoxn	109.6	344	uA/V^2
uCoxp	39.4	72.6	uA/V^2
Cox	2.51	8.5	fF/μm^2
Vdd	5	1.8	V
fosc-31	94.5	402.8	MHz

Assume n-channel and p-channel devices with $L=L_{min}$, $W=1.5L_{min}$

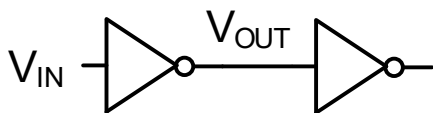

$$t_{HL} = R_{pd} C_L$$

$$t_{LH} = R_{pu} C_L$$

$$R_{pd} = \frac{L_n}{\mu_n C_{OX} W_n (V_{DD} - V_{TN})}$$

$$R_{pu} = \frac{L_p}{\mu_p C_{OX} W_p (V_{DD} + V_{TP})}$$

$$C_L = C_{OX} (W_n L_n + W_p L_p)$$

Feature	0.5	0.18	Units
CL	1.88	0.83	fF
Rpd	1452	1491	ohms
Rpu	2858	3941	ohms
THL	2.73	1.23	psec
TLH	5.38	3.26	psec
f	123	223	GHz

Note 0.18u process is much faster than 0.5u process

Some scale even faster

Basic Devices and Device Models

- Resistor
- Diode
- Capacitor
- MOSFET
- BJT



Lets pick up a discussion of
Technology Files before moving to BJT

Return to basic devices !

Basic Devices and Device Models

- Resistor
- Diode
- Capacitor
- MOSFET

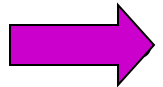

BJT

Bipolar Junction Transistors

- Operation
- Modeling

Carriers in Doped Semiconductors

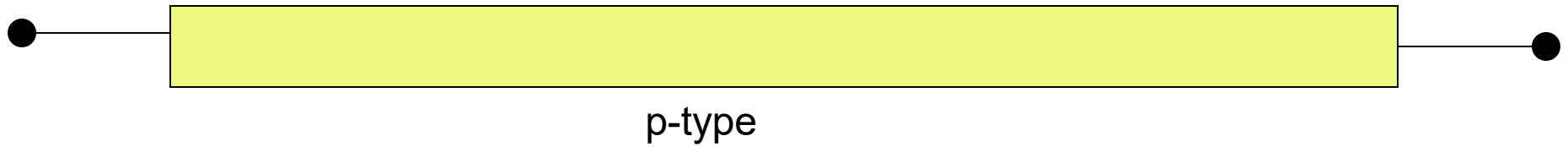

Carriers in Doped Semiconductors

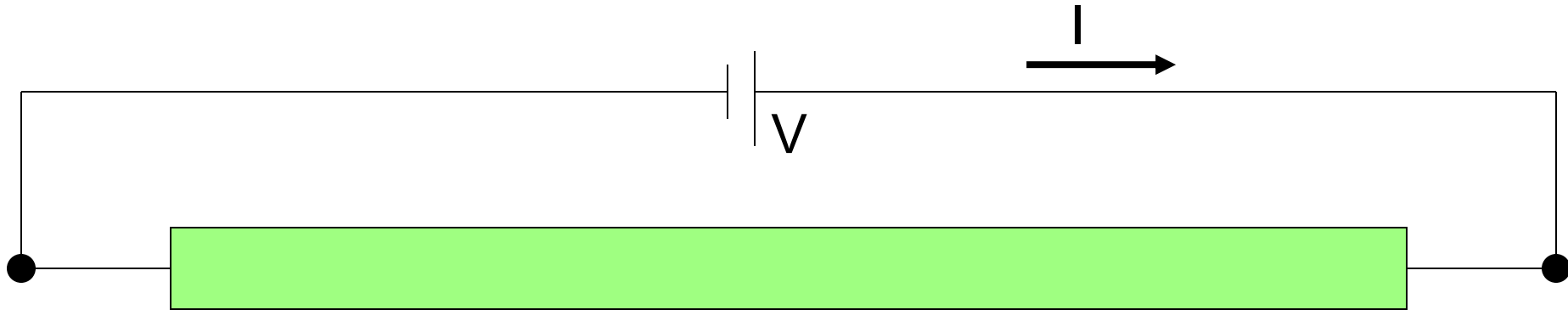

Current carriers are dominantly electrons

Small number of holes are short-term carriers

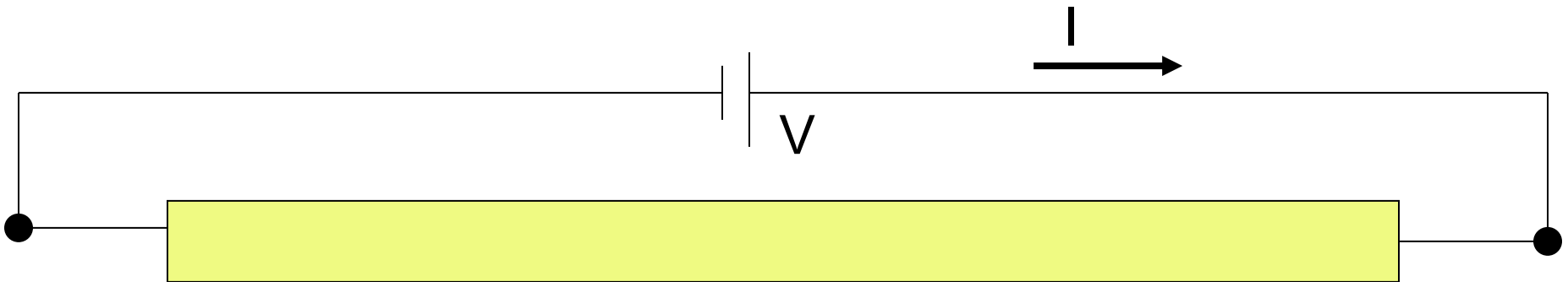

Current carriers are dominantly holes

Small number of electrons are short-term carriers

Carriers in Doped Semiconductors

	Majority Carriers	Minority Carriers
n-type	electrons	holes
p-type	holes	electrons

Carriers in MOS Transistors

Consider n-channel MOSFET

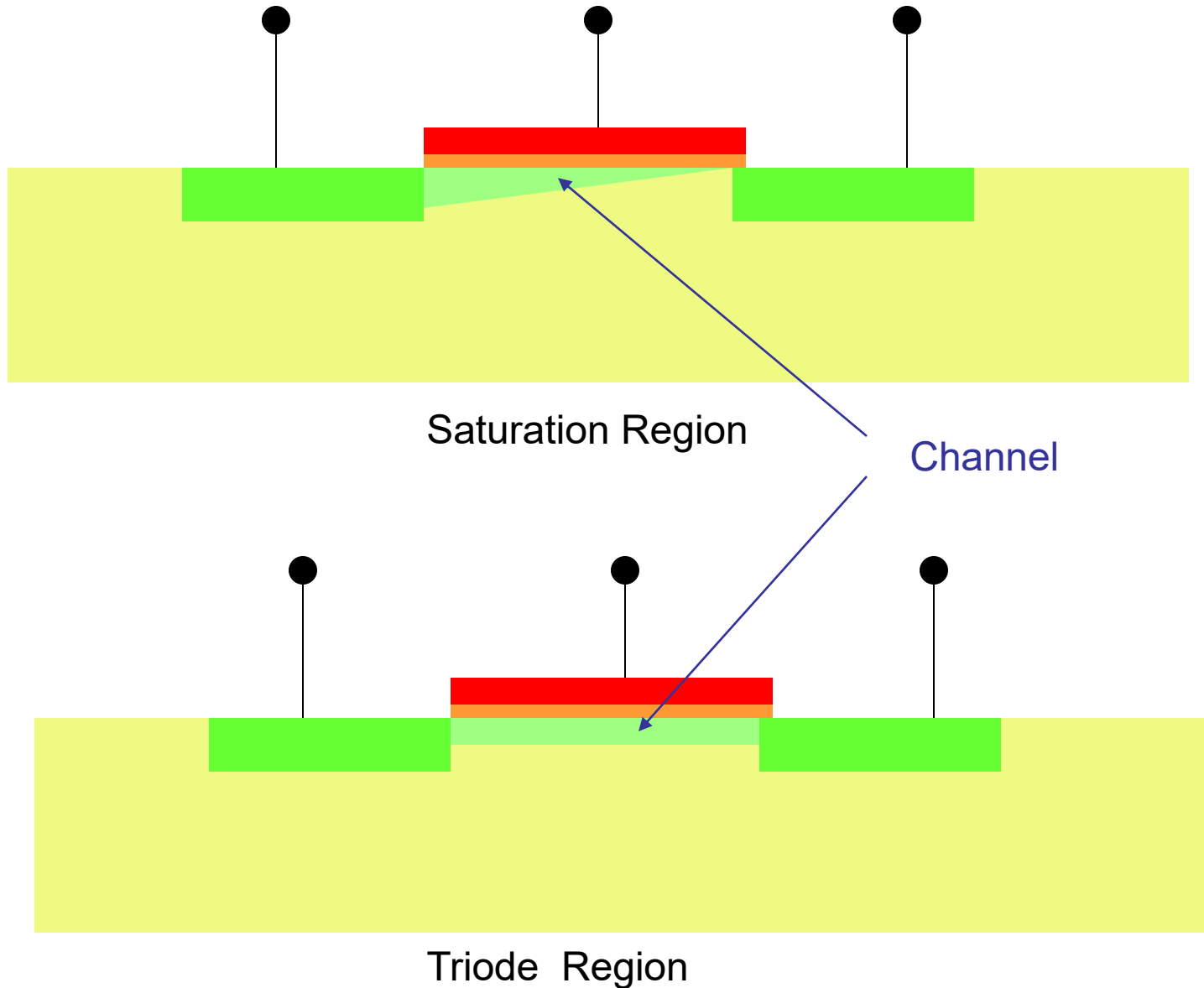

Carriers in MOS Transistors

Consider n-channel MOSFET

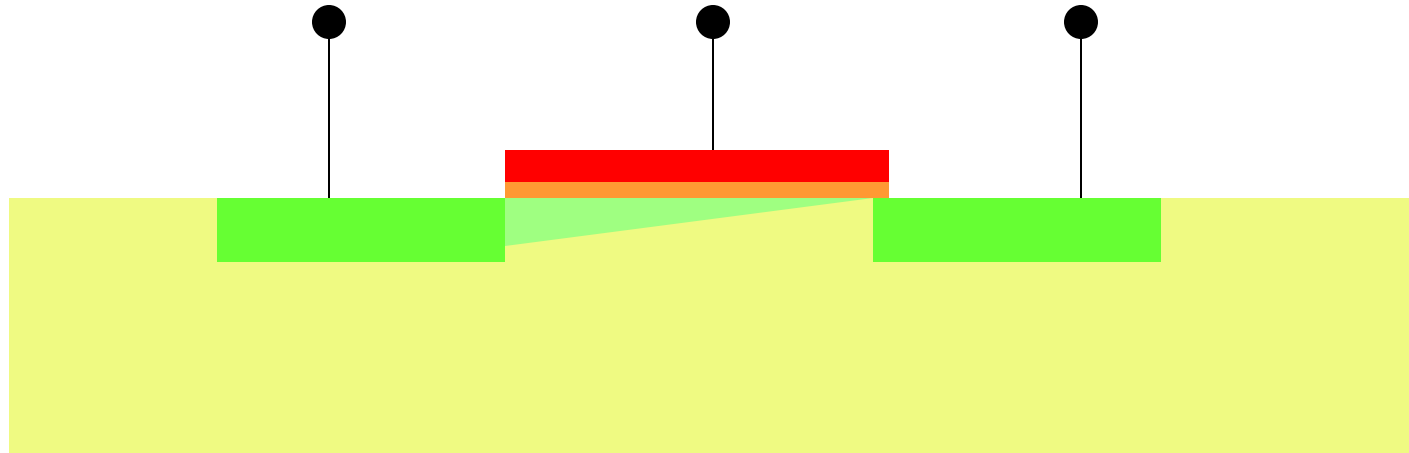

Saturation Region

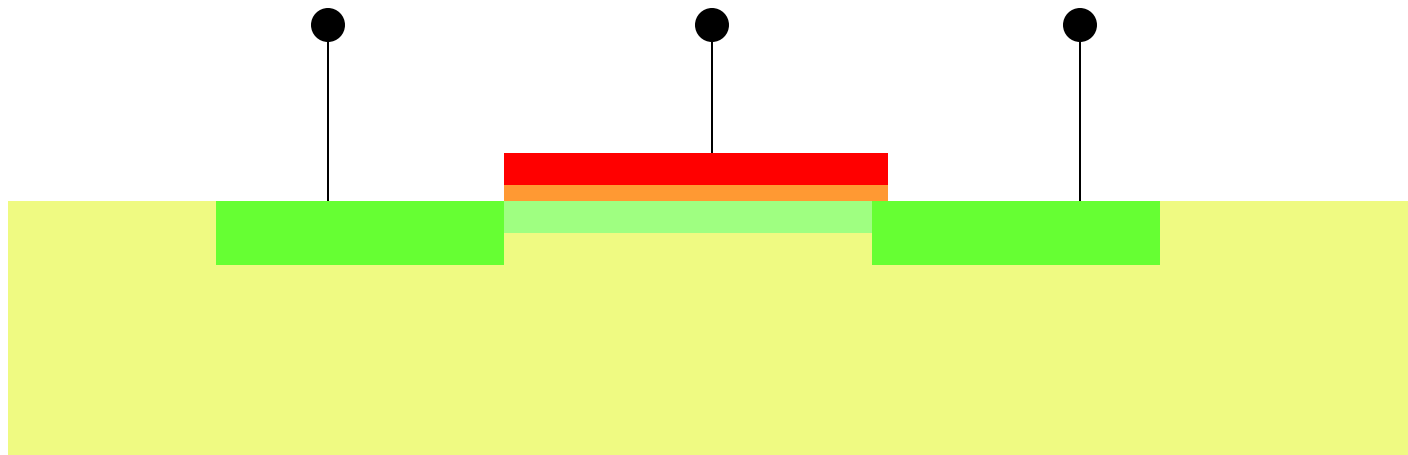

Triode Region

Carriers in electrically induced n-channel are electrons

Carriers in MOS Transistors

Consider p-channel MOSFET

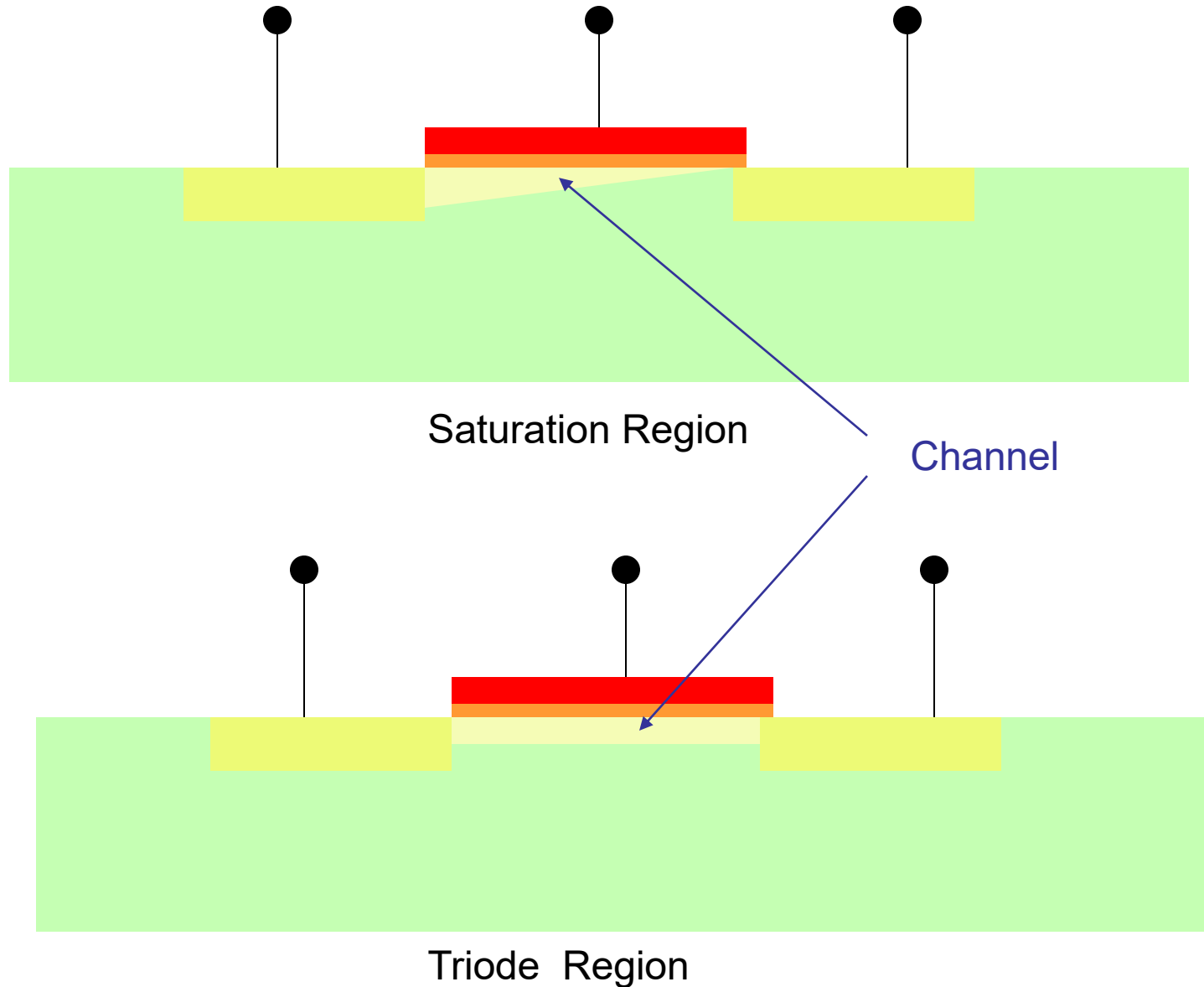

Carriers in MOS Transistors

Consider p-channel MOSFET

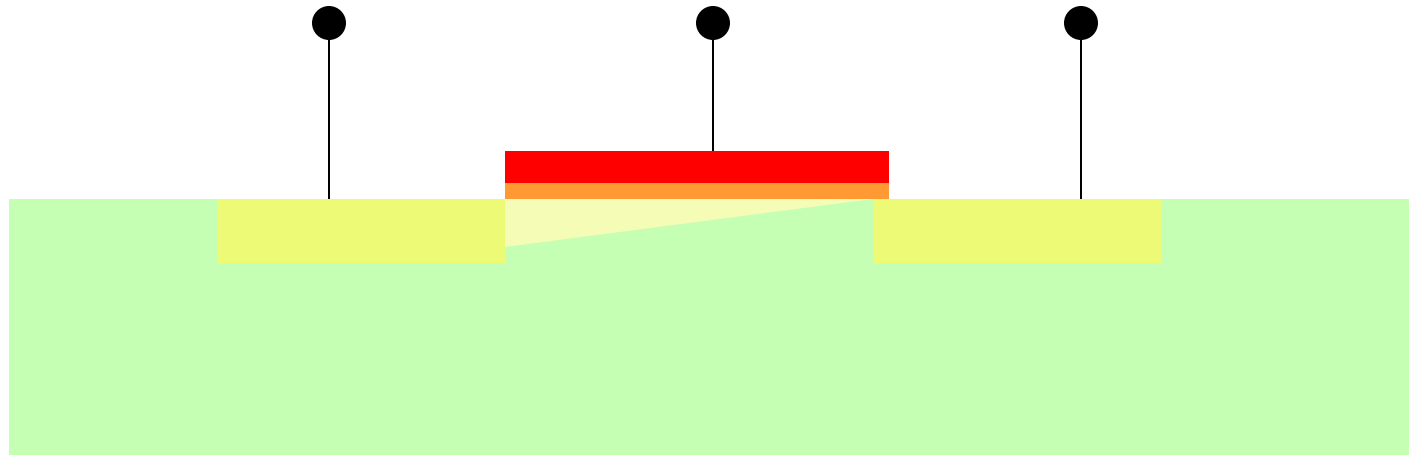

Saturation Region

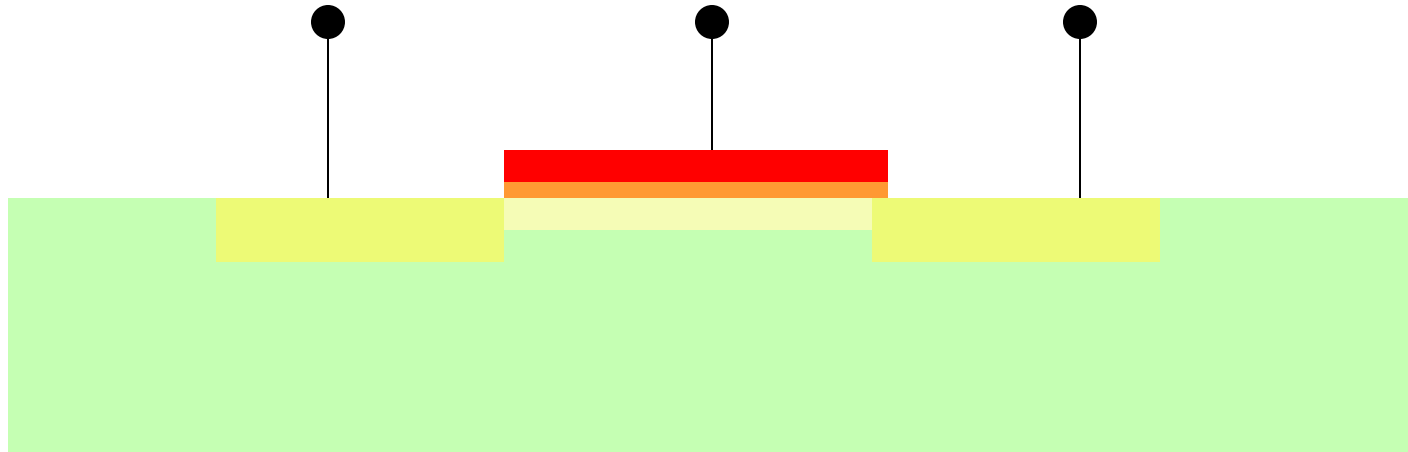

Triode Region

Carriers in electrically induced p-channel are holes

Carriers in MOS Transistors

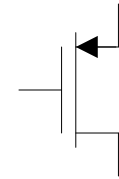
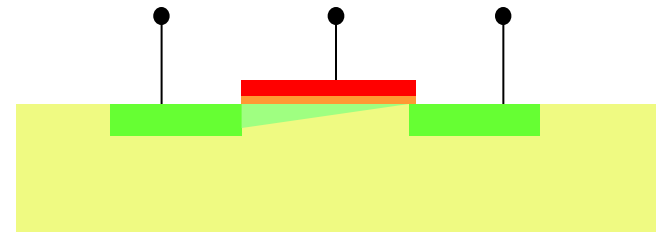
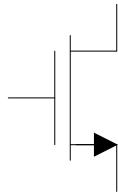
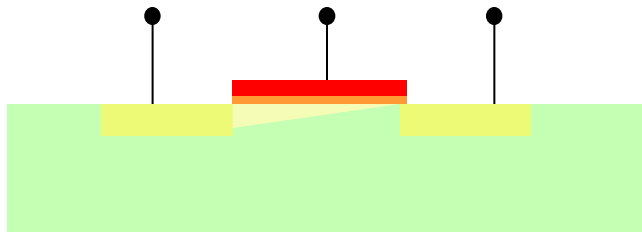

Carriers in channel of MOS transistors are Majority carriers

Bipolar Transistors

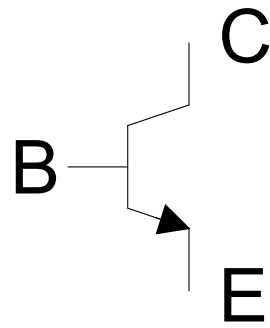
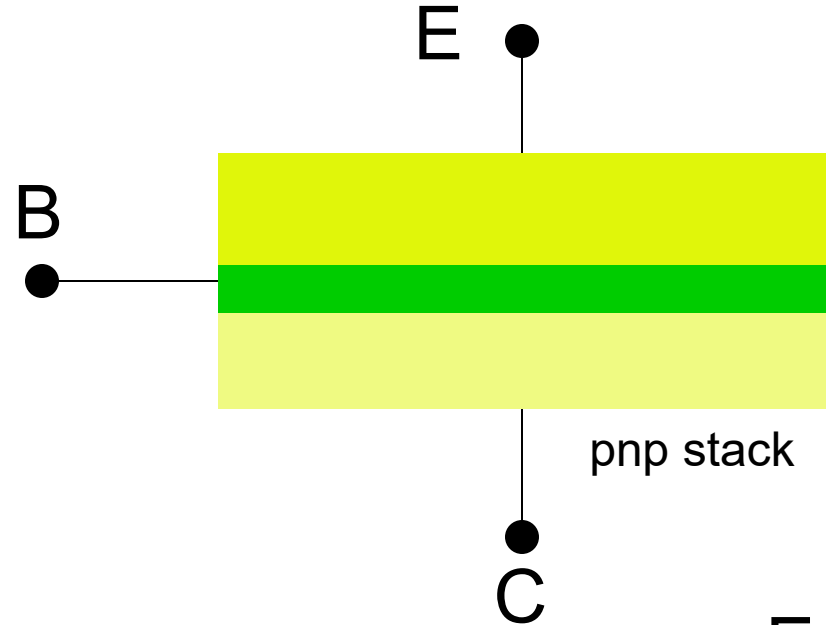
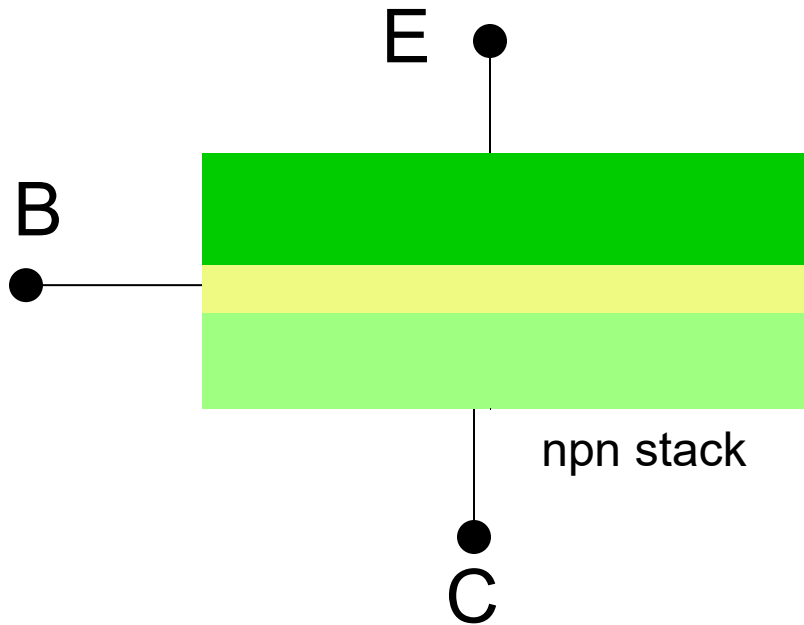

npn transistor

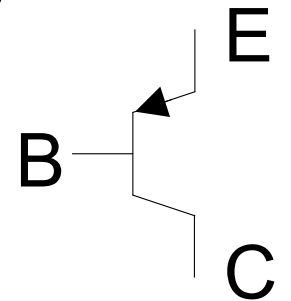

pnp transistor

- Bipolar Devices Show Basic Symmetry
- Electrical Properties not Symmetric
- Designation of C and E critical

With proper doping and device sizing these form Bipolar Transistors

Bipolar Transistors

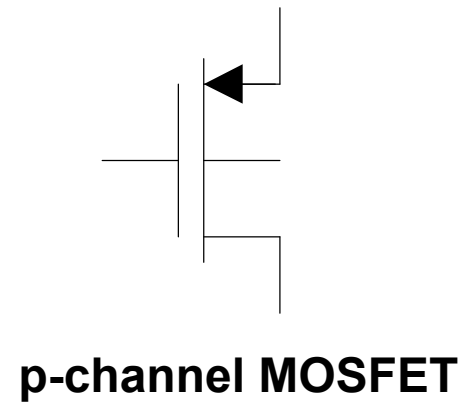
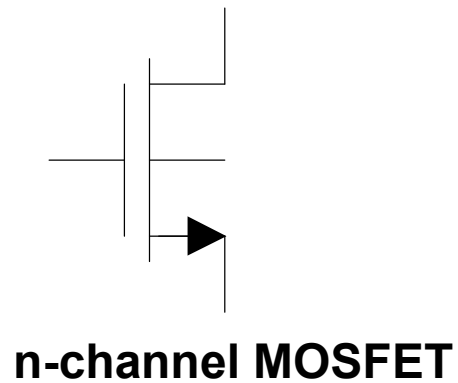
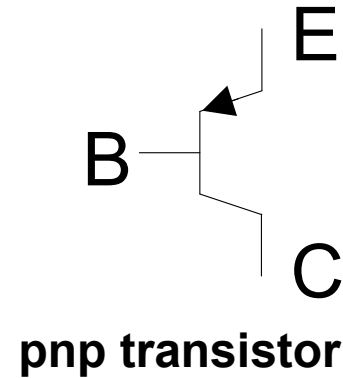
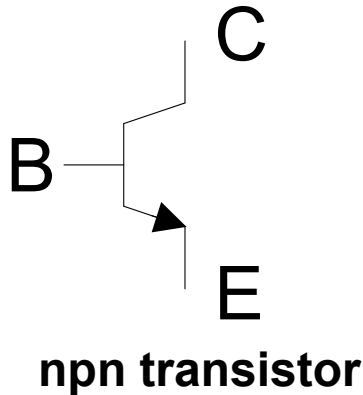

In contrast to a MOSFET which has 4 terminals, a BJT only has 3 terminals

Bipolar Operation

Consider npn transistor – Forward Active Operation

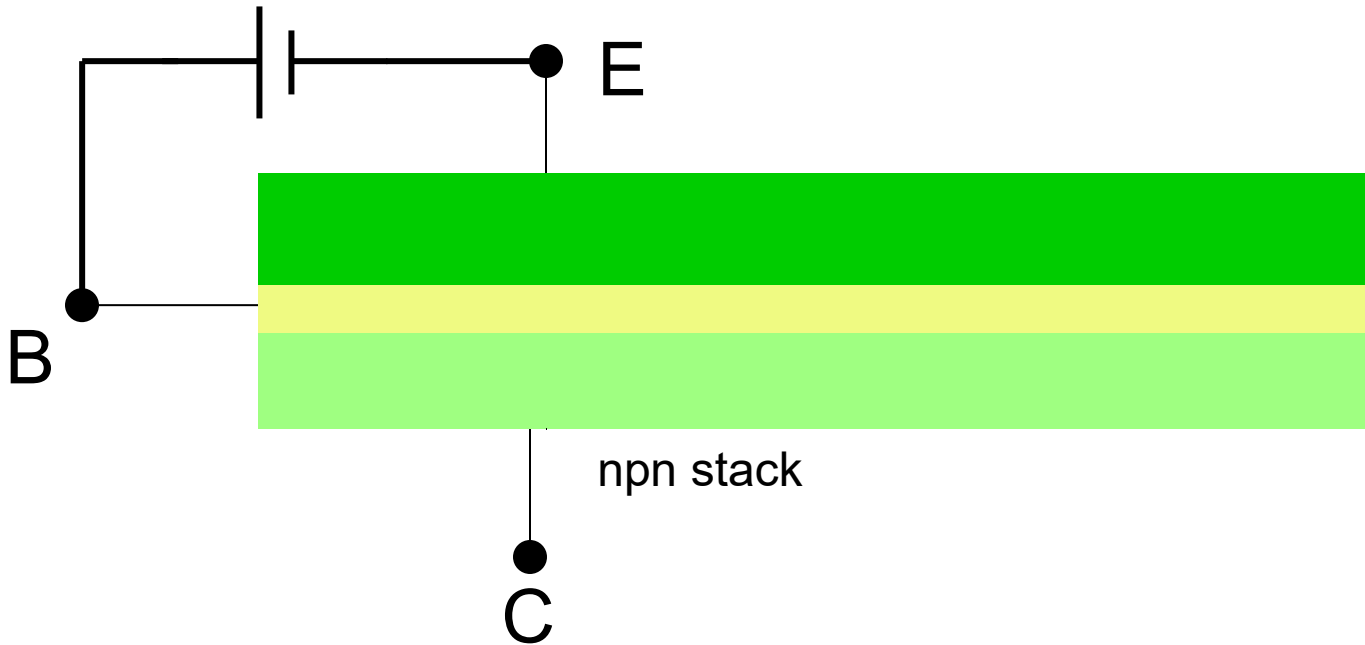

Under **forward BE bias** current flow into base and out of emitter

Current flow is governed by the diode equation

Carriers in emitter are electrons (majority carriers)

When electrons pass into the base they become minority carriers

Quickly recombine with holes to create holes in base region

Dominant current flow in base is holes (majority carriers)

Bipolar Operation

Consider npn transistor – Forward Active Operation

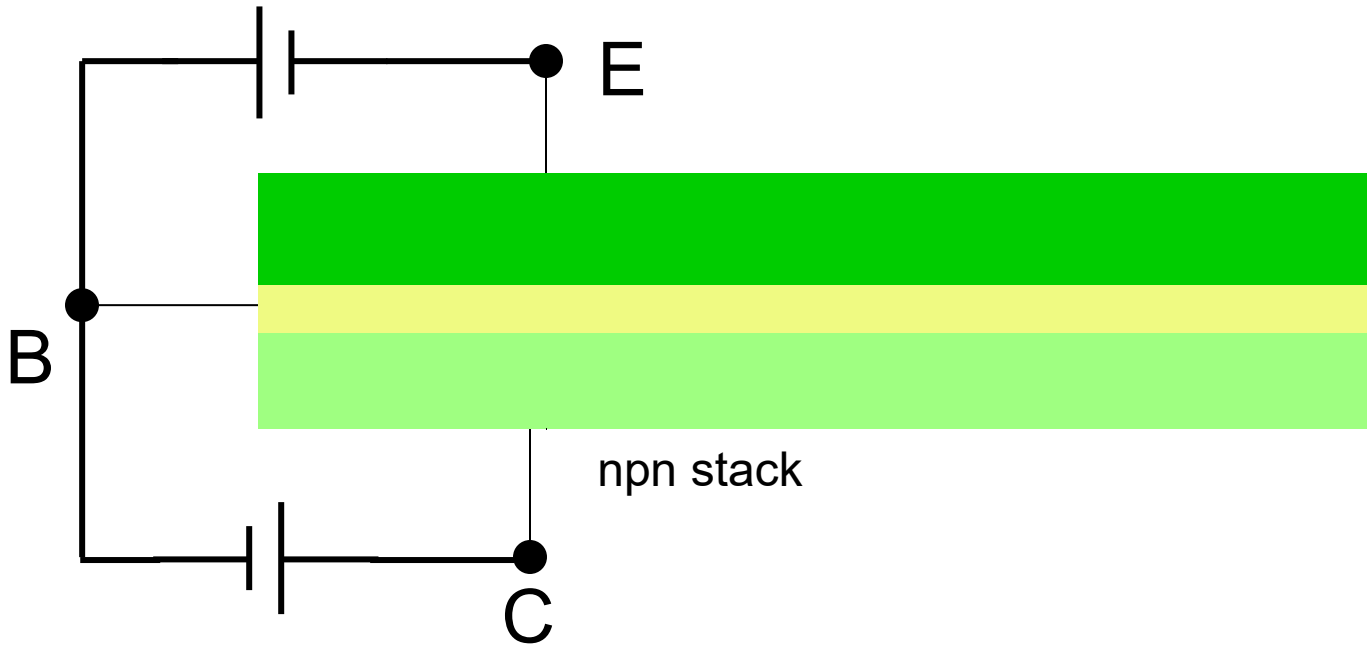

Under forward BE bias and reverse BC bias current flows into base **region**

Carriers in emitter are electrons (majority carriers)

When electrons pass into the base they become minority carriers

When minority carriers are present in the base they can be attracted to collector

Bipolar Operation

Consider npn transistor – Forward Active Operation

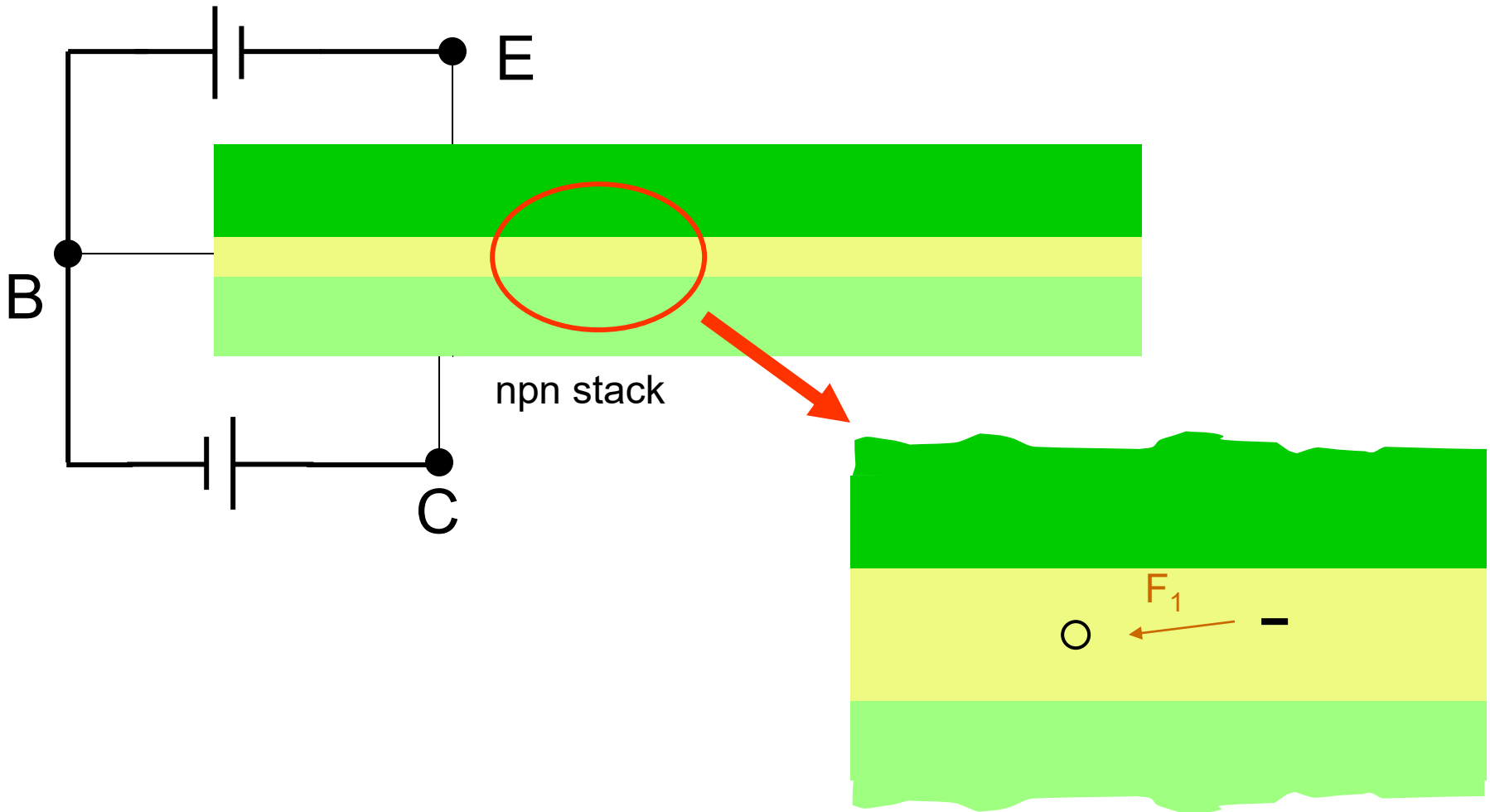

If no force on electron is applied by collector, electron will contribute to base current

Bipolar Operation

Consider npn transistor – Forward Active Operation

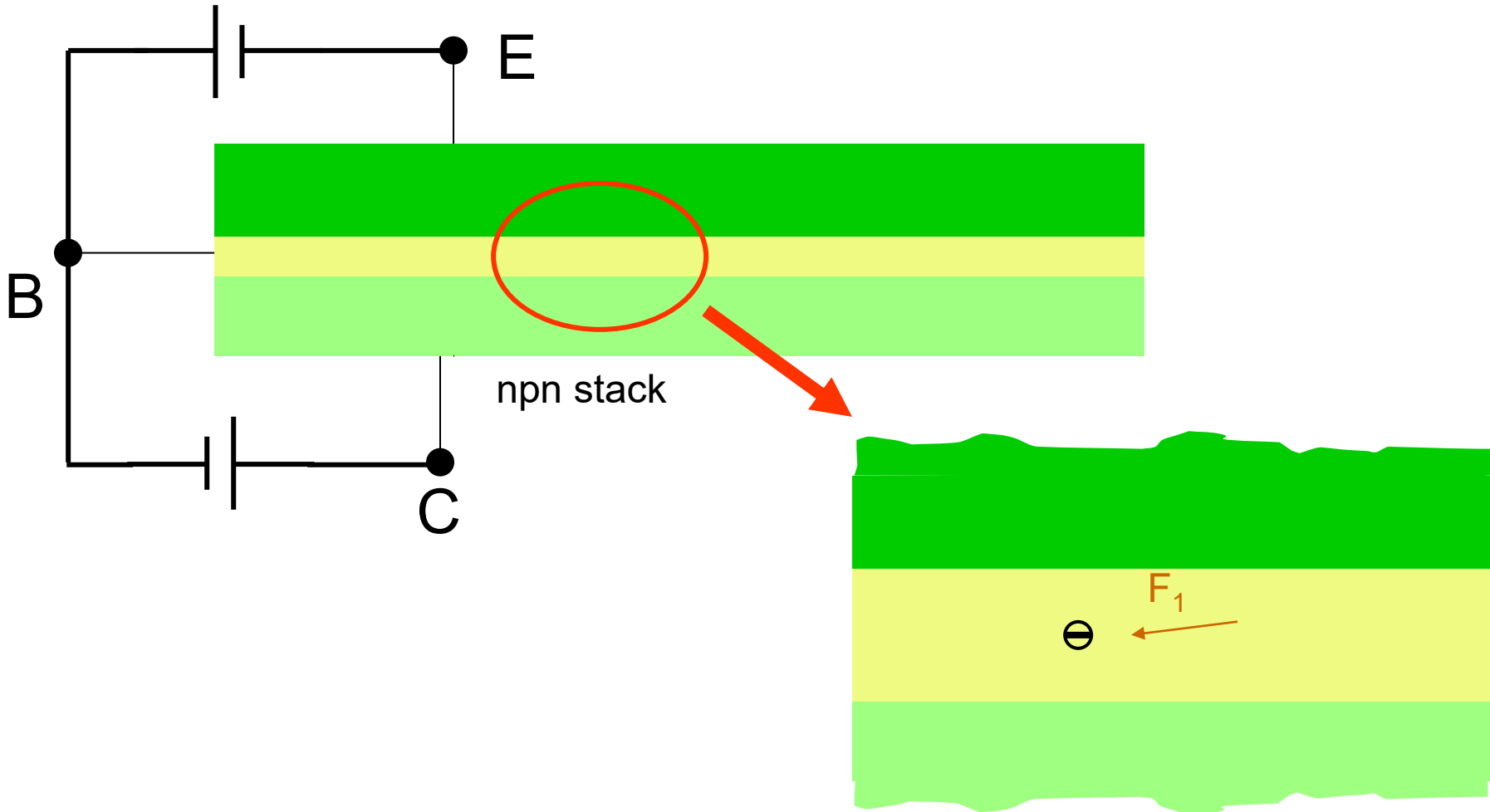

If no force on electron is applied by collector, electron will contribute to base current
Electron will recombine with a hole so dominant current flow in base will be by majority carriers

Bipolar Operation

Consider npn transistor – Forward Active Operation

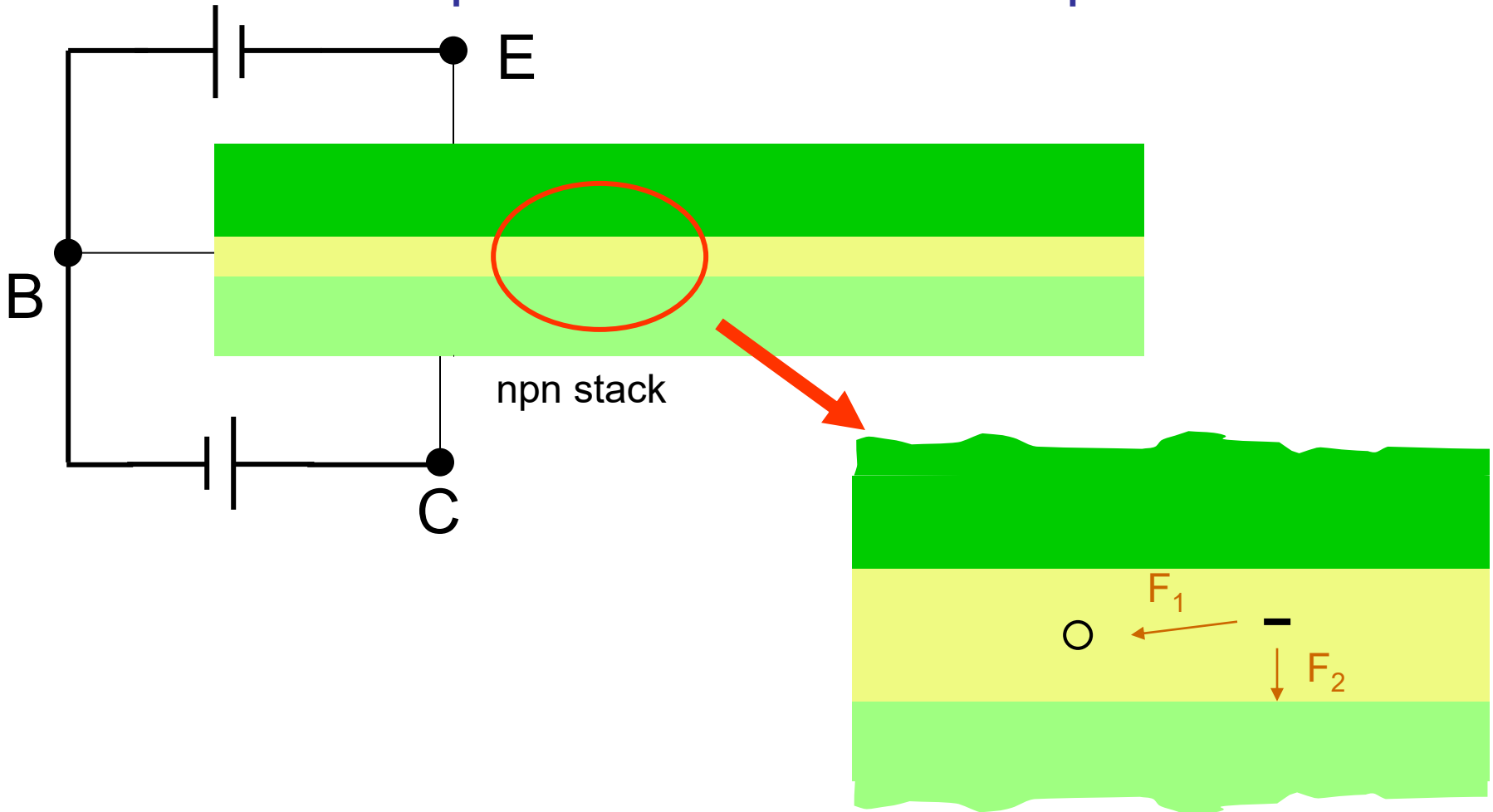

When minority carriers are present in the base they can be attracted to collector with reverse-bias of BC junction and can move across BC junction

Bipolar Operation

Consider npn transistor – Forward Active Operation

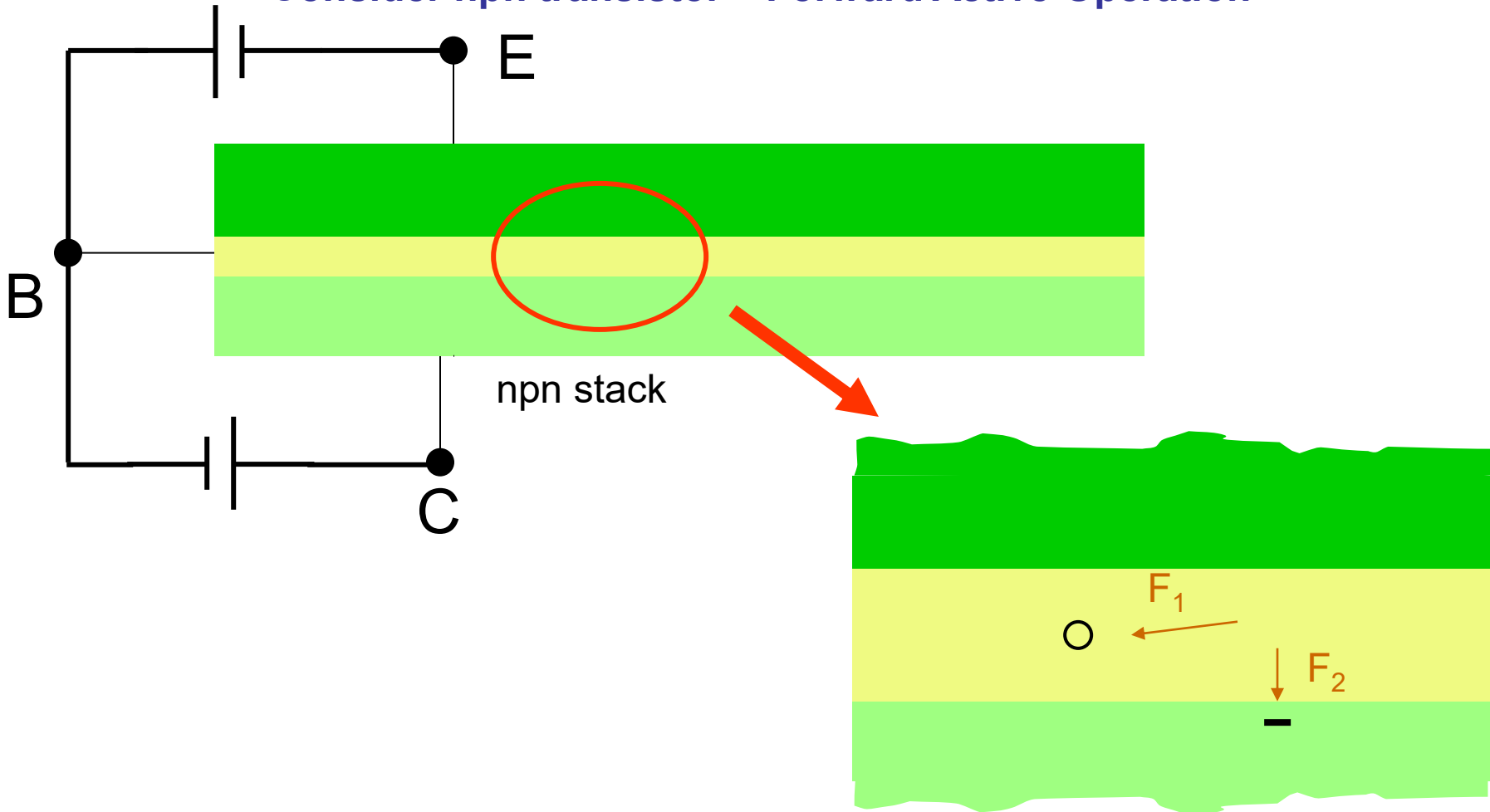

When minority carriers are present in the base they can be attracted to collector with reverse-bias of BC junction and can move across BC junction

Will contribute to collector current flow as majority carriers

Bipolar Operation

Consider npn transistor – Forward Active Operation

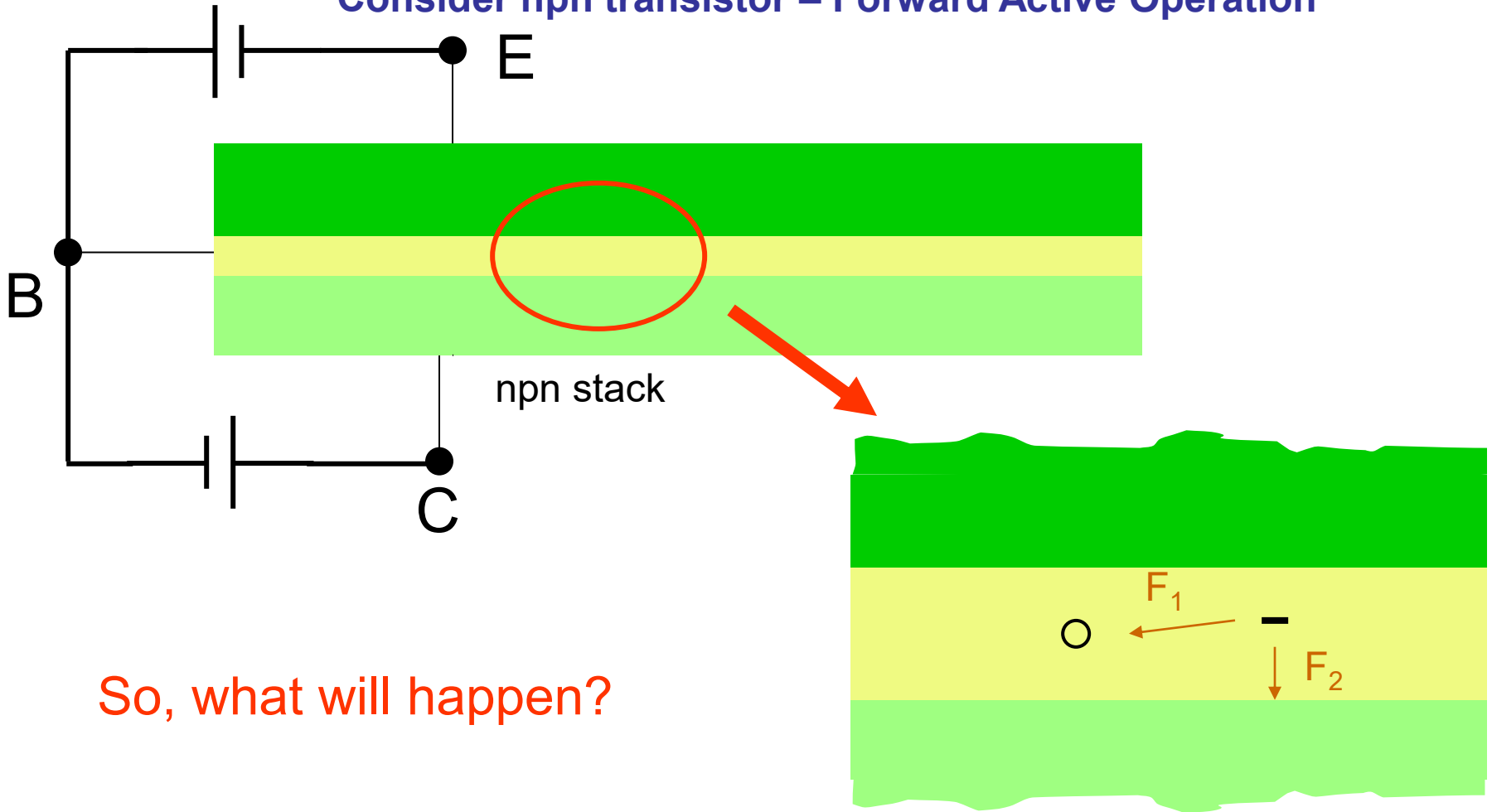

So, what will happen?

Bipolar Operation

Consider npn transistor – Forward Active Operation

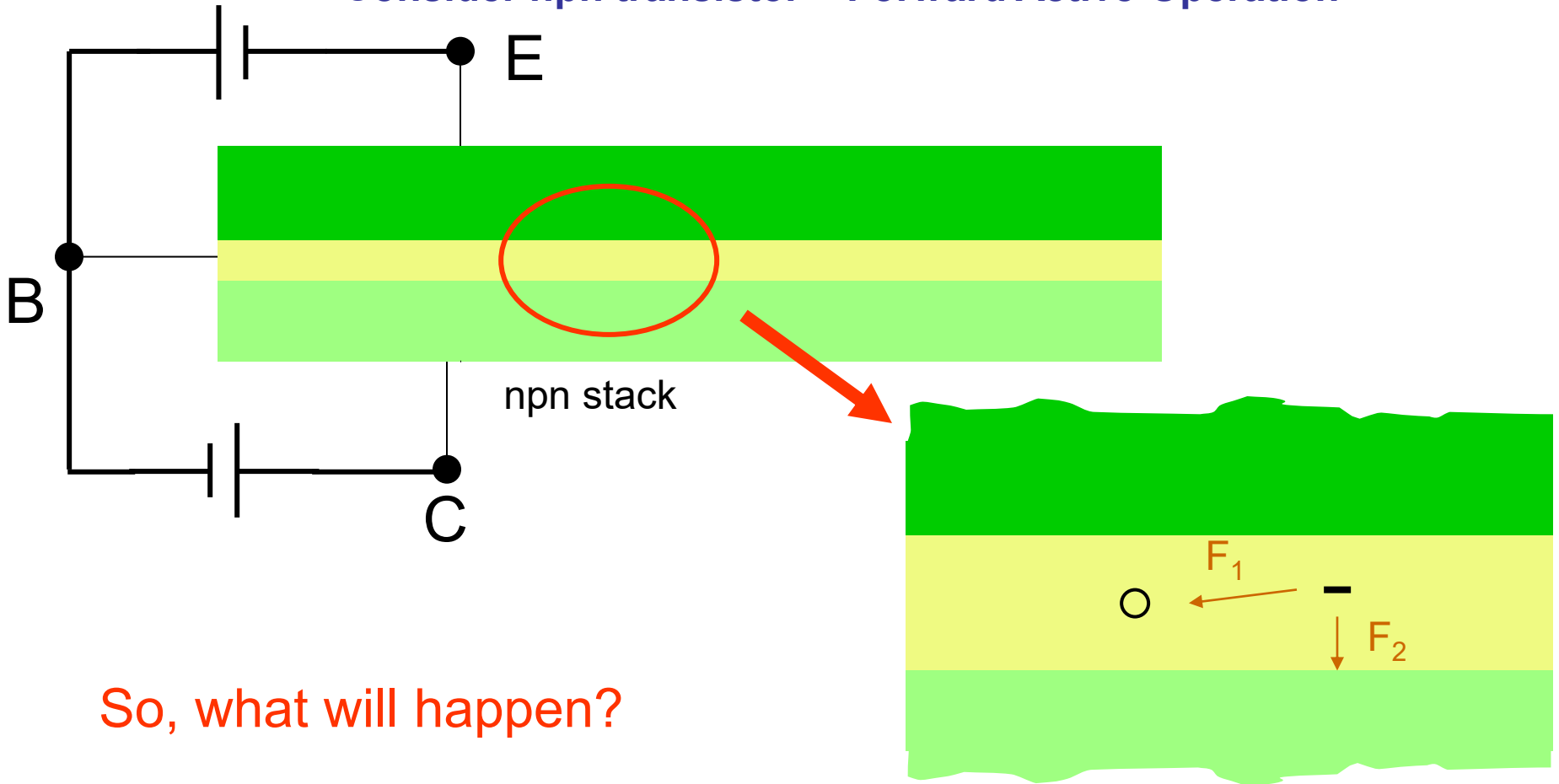

So, what will happen?

Some will recombine with holes and contribute to base current and some will be attracted across BC junction and contribute to collector

Size and thickness of base region and relative doping levels will play key role in percent of minority carriers injected into base contributing to collector current

Bipolar Operation

Consider npn transistor – Forward Active operation

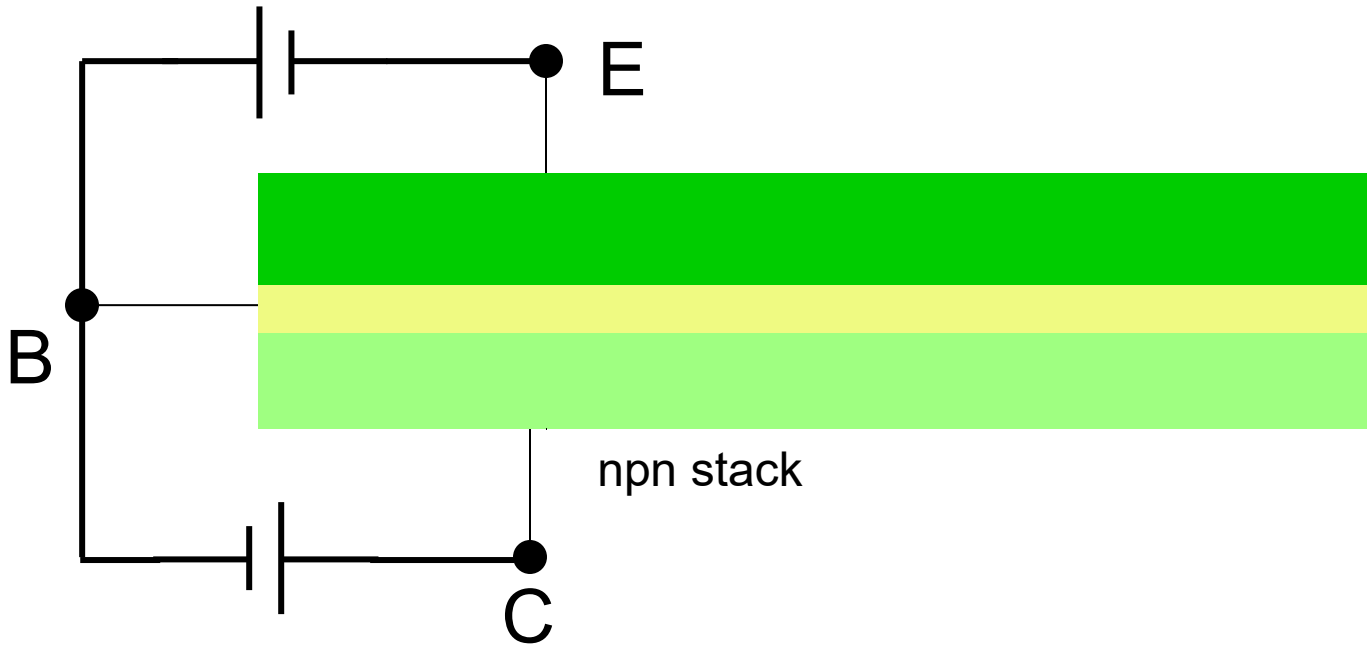

Under forward BE bias and reverse BC bias current flows into base region

Carriers in emitter are electrons (majority carriers)

When electrons pass into the base they become minority carriers

When minority carriers are present in the base they can be attracted to collector

Minority carriers either recombine with holes and contribute to base current or are attracted into collector region and contribute to collector current

Bipolar Operation

Consider npn transistor – Forward Active operation

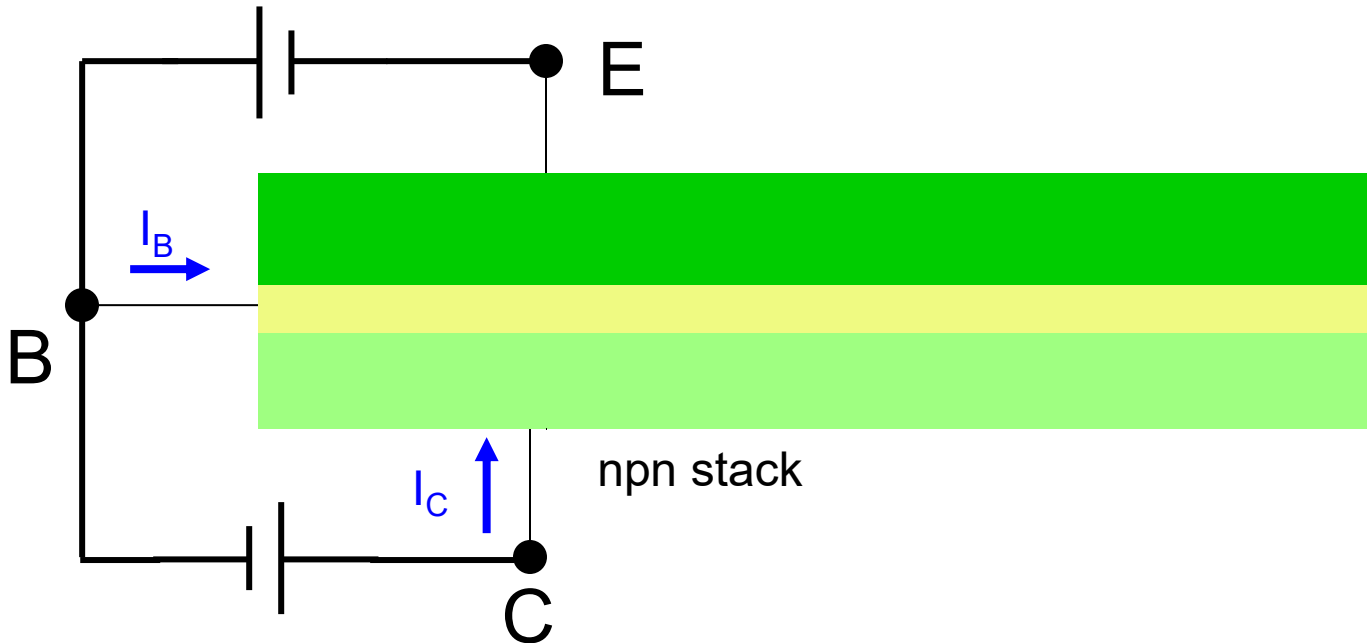

Minority carriers either recombine with holes and contribute to base current or are attracted into collector region and contribute to collector current

If most of the minority carriers are attracted to collector, $|I_C| \simeq |I_E|$

Thus $I_B \ll I_C$

Implications of this observation?

If input to device is I_B and output is I_C , the BJT will behave as a current amplifier with large current gain !! This was the key observation by Bell Labs in 1948 !!

Bipolar Operation

Consider npn transistor - Forward Active Operation

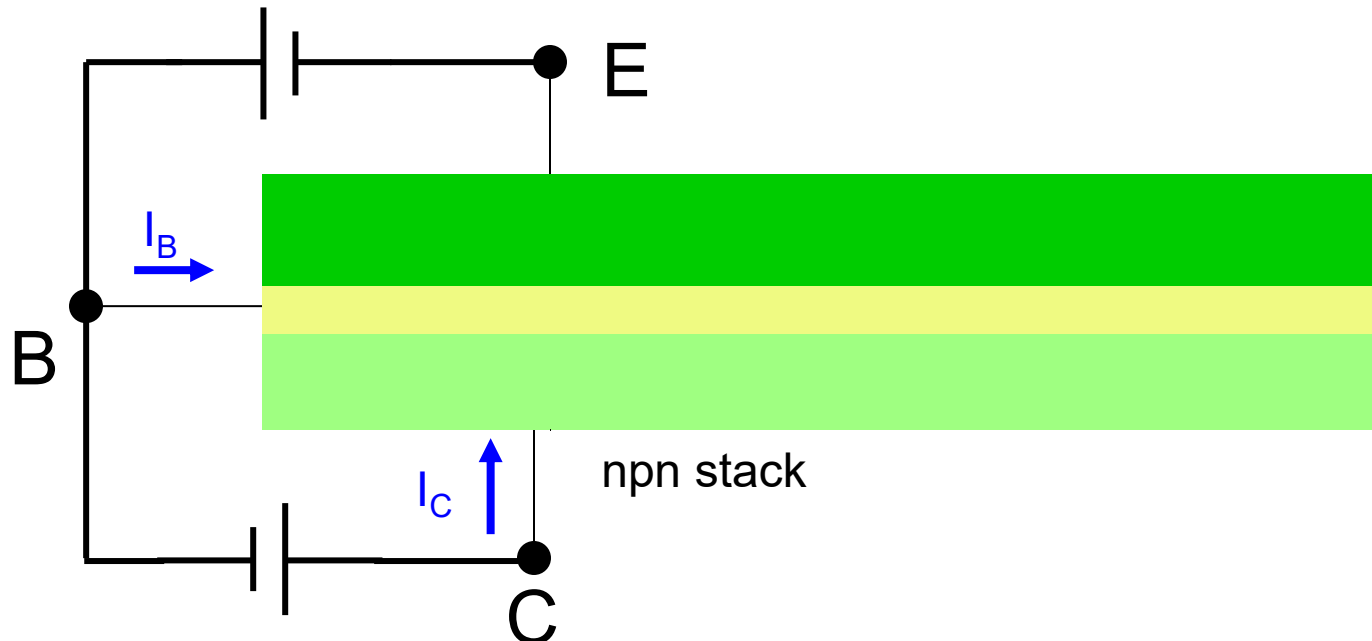

Under forward BE bias and reverse BC bias current flows into base region

- Efficiency at which minority carriers injected into base region and contribute to collector current is termed α
- α is always less than 1 but for a good transistor, it is very close to 1
- For good transistors $.99 < \alpha < .999$
- Making the base region very thin makes α large

Bipolar Transistors

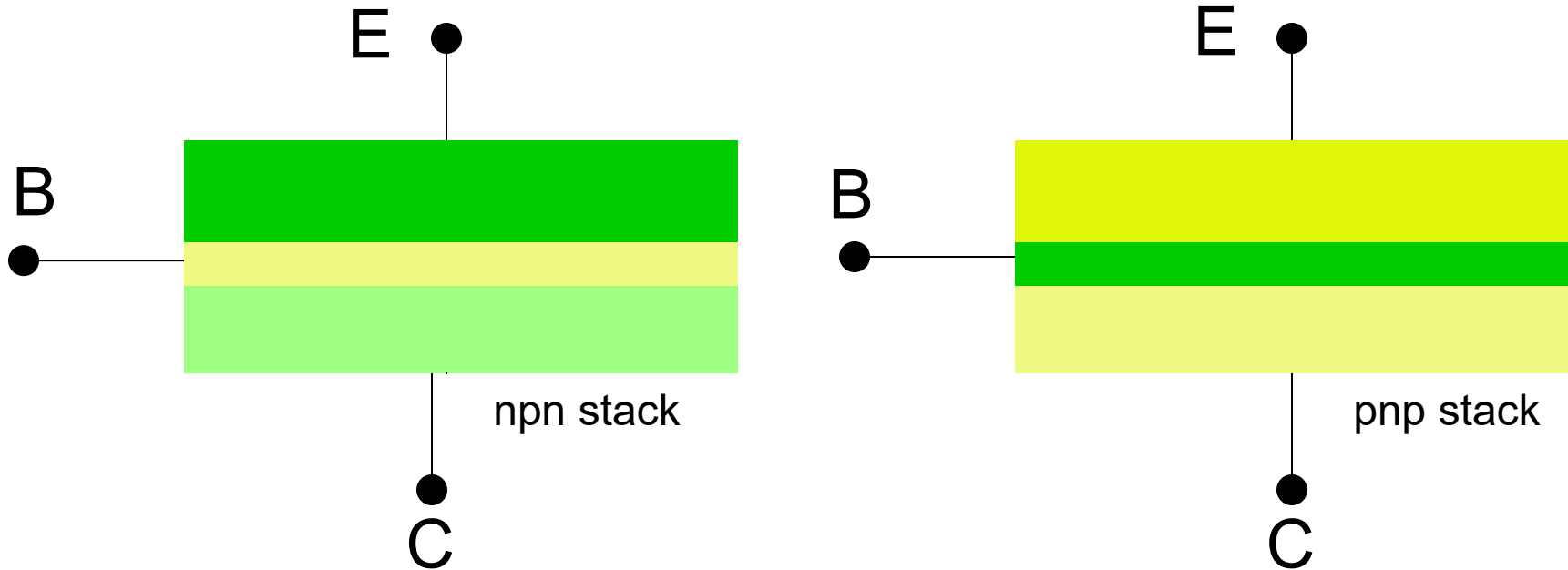

- principle of operation of pnp and npn transistors are the same
- minority carriers in base of pnp are holes
- npn usually have modestly superior properties because mobility of electrons is larger than mobility of holes

Bipolar Operation

Consider npn transistor – Forward Active Operation

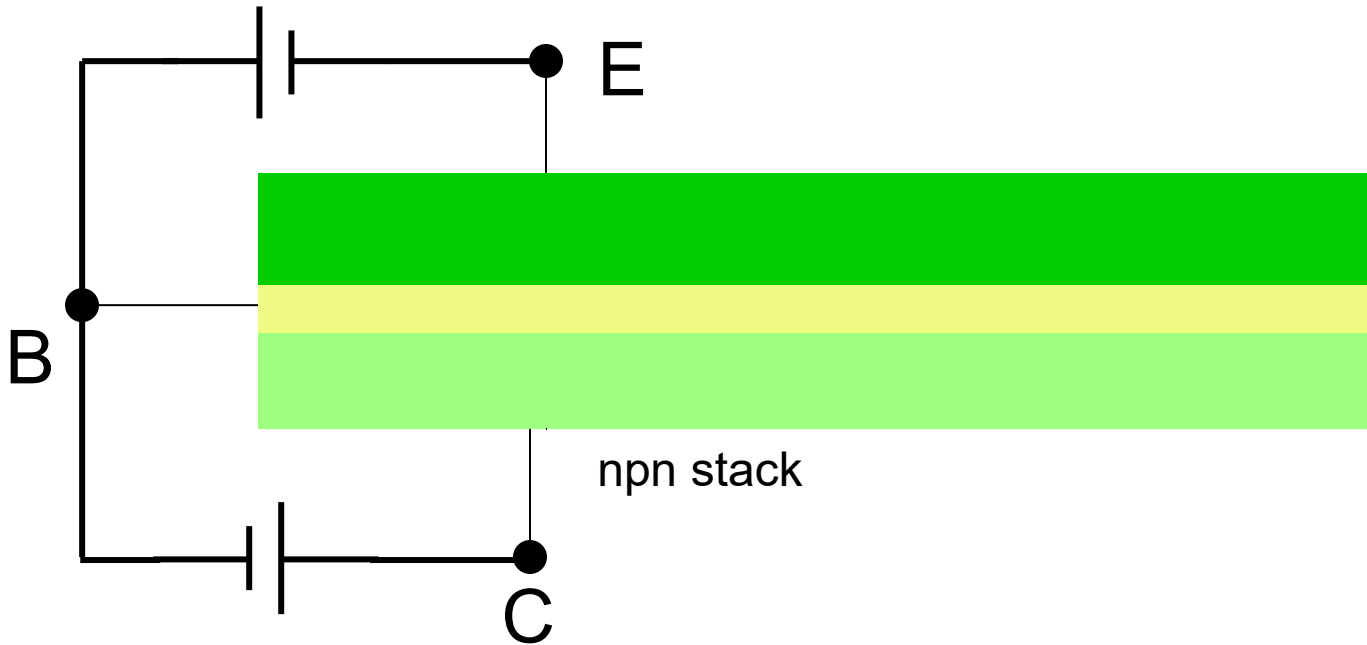

In contrast to MOS devices where current flow in channel is by majority carriers, current flow in the critical base region of bipolar transistors is by minority carriers

Bipolar Operation

Consider npn transistor – Forward Active Operation

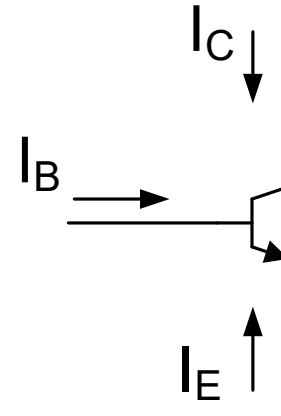
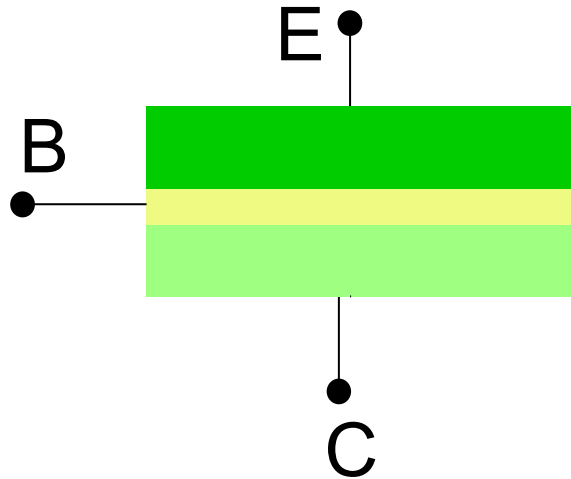

$$I_C + I_B = -I_E$$

$$I_C = -\alpha I_E$$

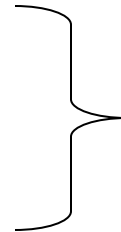

$$I_C = \frac{\alpha}{1-\alpha} I_B$$

$$\beta \stackrel{\text{defn}}{=} \frac{\alpha}{1-\alpha}$$

$$I_C = \beta I_B$$

β is typically very large

often $50 < \beta < 999$

Bipolar Operation

Consider npn transistor – Forward Active Operation

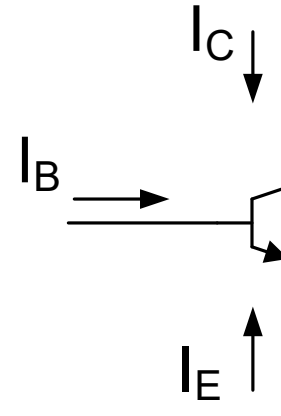
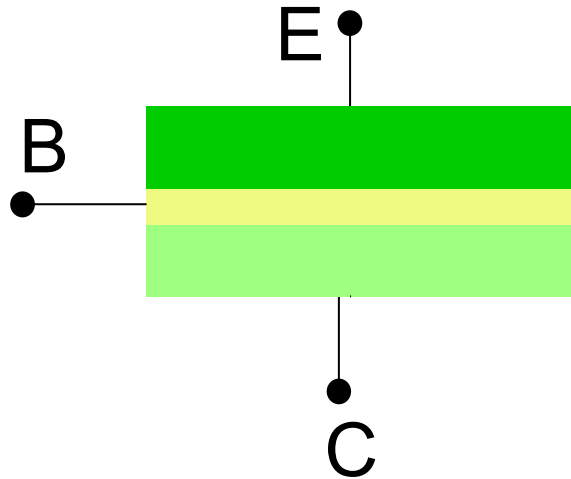

$$I_C = \beta I_B$$

β is typically very large

Bipolar transistor can be thought of a current amplifier with a large current gain

In contrast, MOS transistor is inherently a transconductance amplifier

Current flow in base is governed by the diode equation $I_B = \tilde{I}_S e^{\frac{V_{BE}}{V_t}}$

Collector current thus varies exponentially with V_{BE} $I_C = \beta \tilde{I}_S e^{\frac{V_{BE}}{V_t}}$

Preliminary Comparison of MOSFET and BJT

(Saturation vs Forward Active)

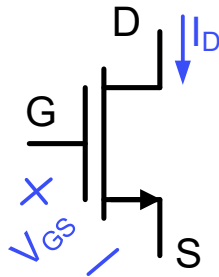
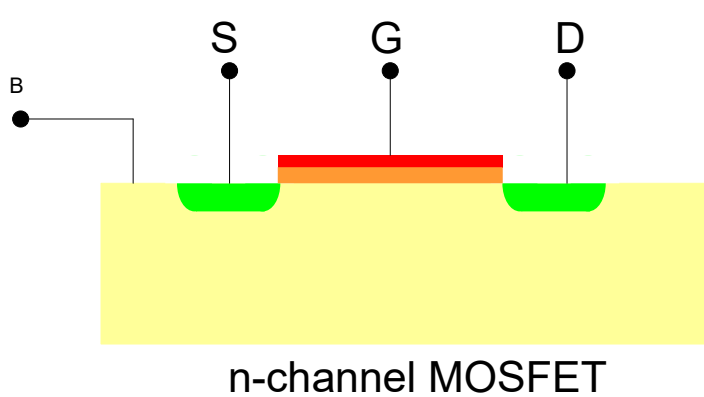

$$I_D = \frac{\mu C_{OX} W}{2L} (V_{GS} - V_{TH})^2$$

I_D independent of V_{DS}

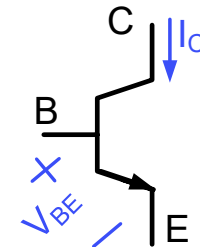
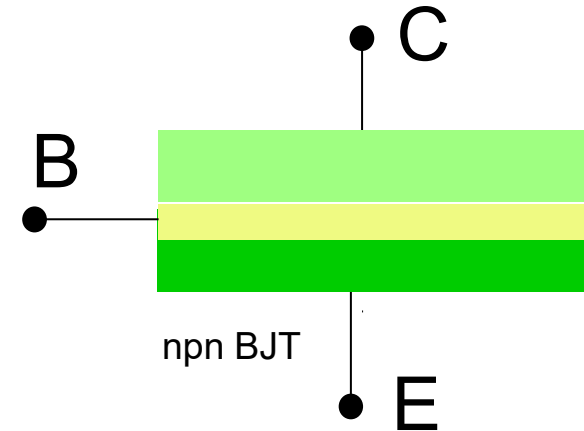

$$I_C = \beta \tilde{I}_S e^{\frac{V_{BE}}{V_t}}$$

I_C independent of V_{CE}



- The BJT I/O relationship is exponential in contrast to square-law for MOSFET
- Provides a very large “gain” for the BJT (assuming input is voltage and output is current)
- This property is very useful for many applications

Bipolar Models

Simple dc Model

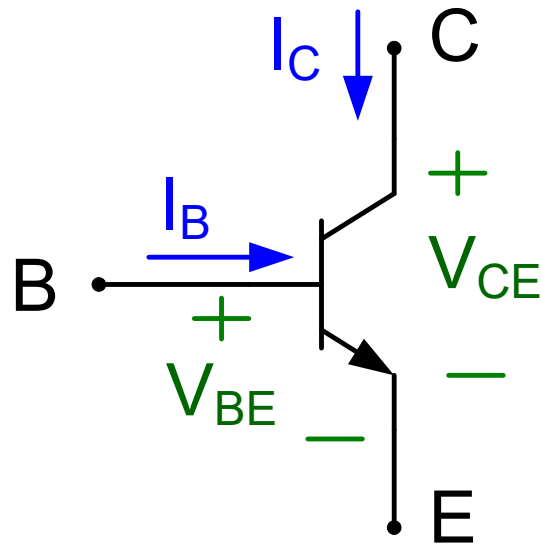

Following convention, pick I_C and I_B as dependent variables and V_{BE} and V_{CE} as independent variables

Simple dc model

Consider npn transistor – Forward Active Operation

Summary:

$$I_B = \tilde{I}_S e^{\frac{V_{BE}}{V_t}}$$

$$I_C = \beta \tilde{I}_S e^{\frac{V_{BE}}{V_t}}$$

$$V_t = \frac{kT}{q}$$

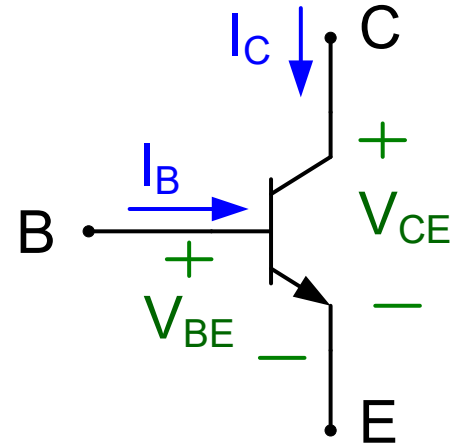

This has the properties we are looking for but the variables we used in introducing these relationships are not standard

It can be shown that \tilde{I}_S is proportional to the emitter area A_E

Define J_S by $\tilde{I}_S = \beta^{-1} J_S A_E$ and substitute this into the above equations

Simple dc model

npn transistor – Forward Active Operation

$$\left. \begin{aligned} I_B &= \tilde{I}_S e^{\frac{V_{BE}}{V_t}} \\ I_C &= \beta \tilde{I}_S e^{\frac{V_{BE}}{V_t}} \\ V_t &= \frac{kT}{q} \end{aligned} \right\} \longrightarrow \left. \begin{aligned} I_B &= \frac{J_S A_E}{\beta} e^{\frac{V_{BE}}{V_t}} \\ I_C &= J_S A_E e^{\frac{V_{BE}}{V_t}} \\ V_t &= \frac{kT}{q} \end{aligned} \right\}$$

$k/q = 8.62 \times 10^{-5}$

J_S is termed the saturation current density

Process Parameters : J_S, β

Design Parameters: A_E

Environmental parameters and physical constants: k, T, q

At room temperature, V_t is around 26mV

J_S very small – around .25fA/ μ^2 at room temperature

Simple dc model

npn transistor – Forward Active Operation

$$\left. \begin{aligned} I_B &= \frac{J_S A_E}{\beta} e^{\frac{V_{BE}}{V_t}} \\ I_C &= J_S A_E e^{\frac{V_{BE}}{V_t}} \end{aligned} \right\}$$

$$V_t = \frac{kT}{q}$$

As with the diode, the parameter J_S is highly temperature dependent

$$J_S = J_{SX} \left[T^m e^{\frac{-V_{G0}}{V_t}} \right]$$

Typical values for parameters: $J_{SX}=20\text{mA}/\mu^2$, $V_{G0}=1.17\text{V}$, $m=2.3$

The parameter β is also somewhat temperature dependent but much weaker temperature dependence than J_{SX} .

Transfer Characteristics

npn transistor – Forward Active Operation

$$J_S = .25 \text{ fA}/\mu^2$$
$$A_E = 400 \mu^2$$

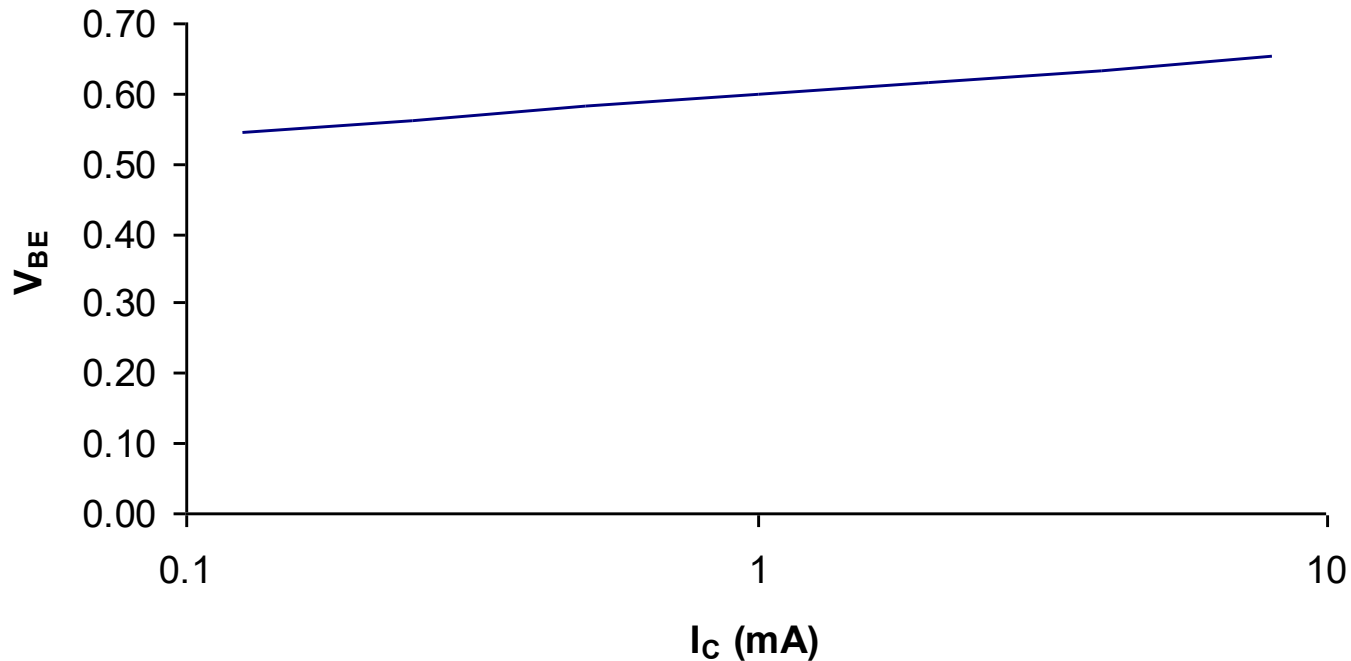

V_{BE} close to 0.6V for a two decade change in I_C around 1mA

Transfer Characteristics

npn transistor – Forward Active Operation

$$J_S = .25 \text{ fA}/\mu^2$$
$$A_E = 400 \mu^2$$

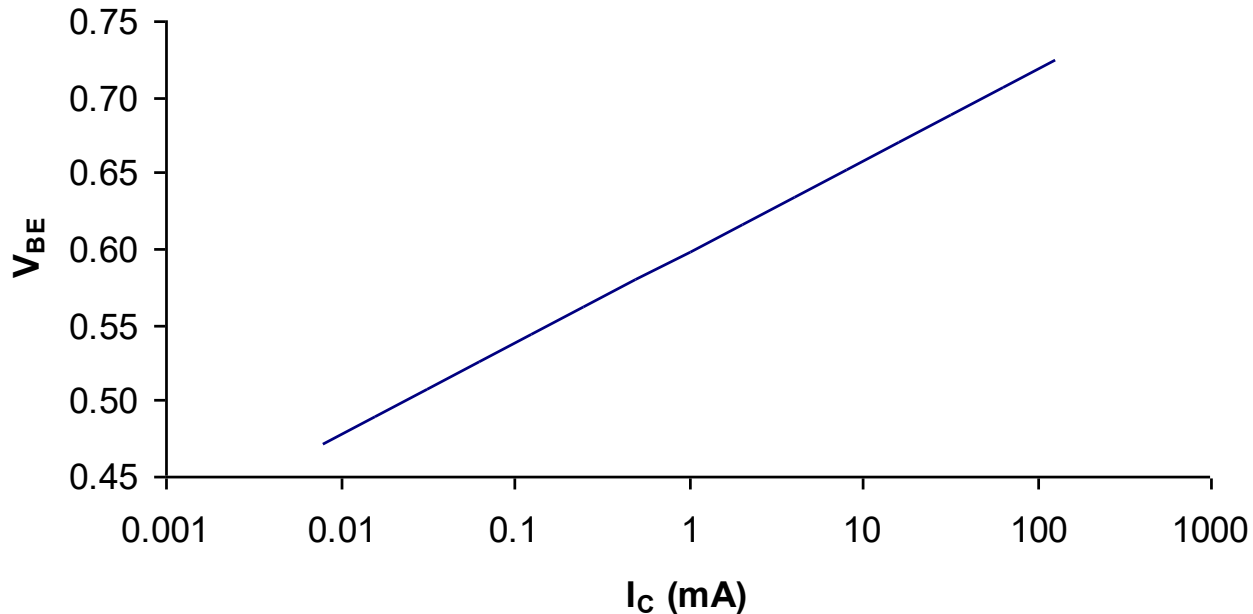

V_{BE} close to 0.6V for a four decade change in I_C around 1mA

Simple dc model

npn transistor – Forward Active Operation

Output Characteristics

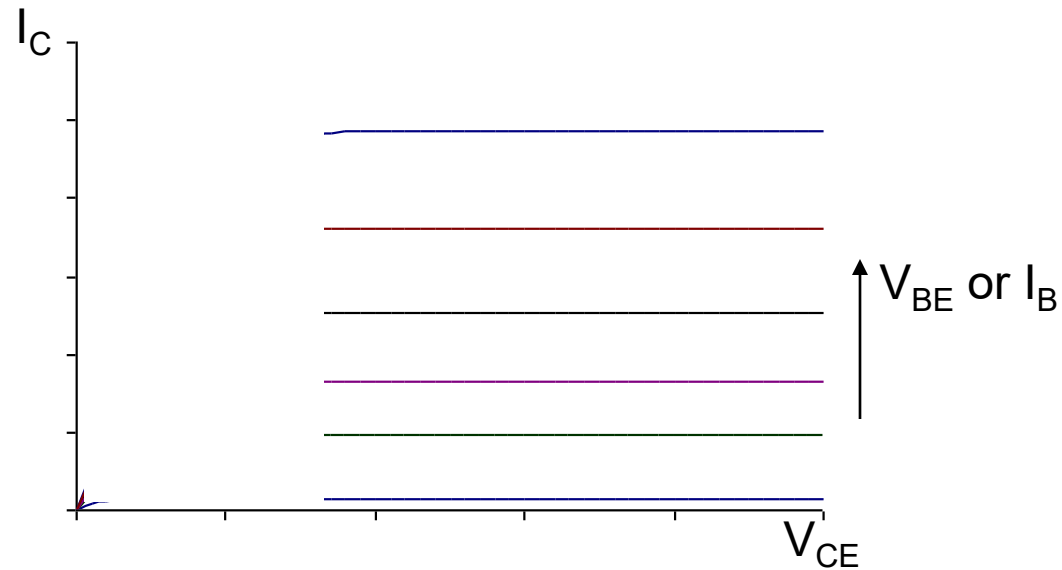

$$I_C = J_S A_E e^{\frac{V_{BE}}{V_t}}$$

Simple dc model

Better Model of Output Characteristics

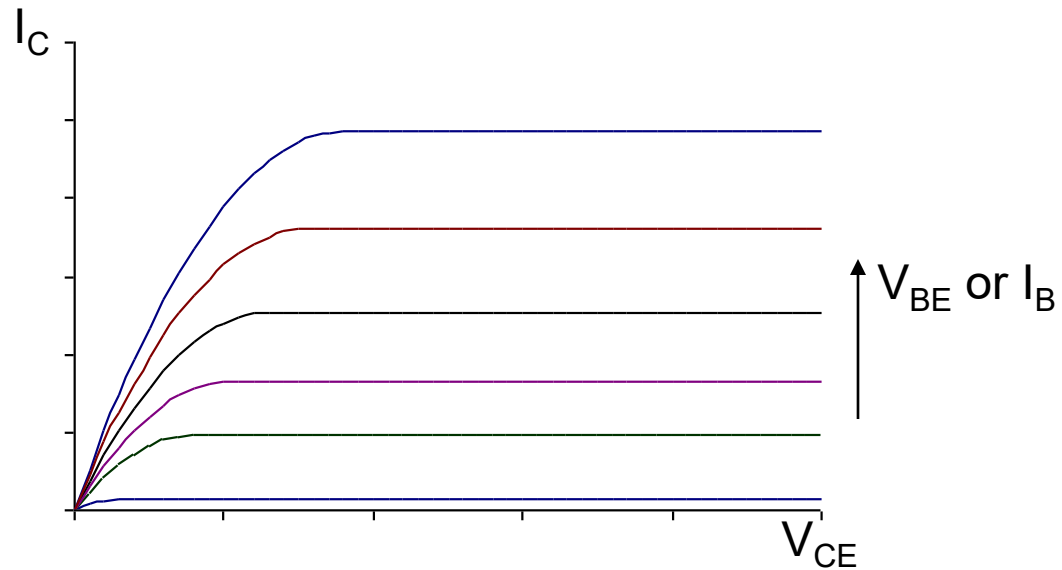

Simple dc model

Typical Output Characteristics

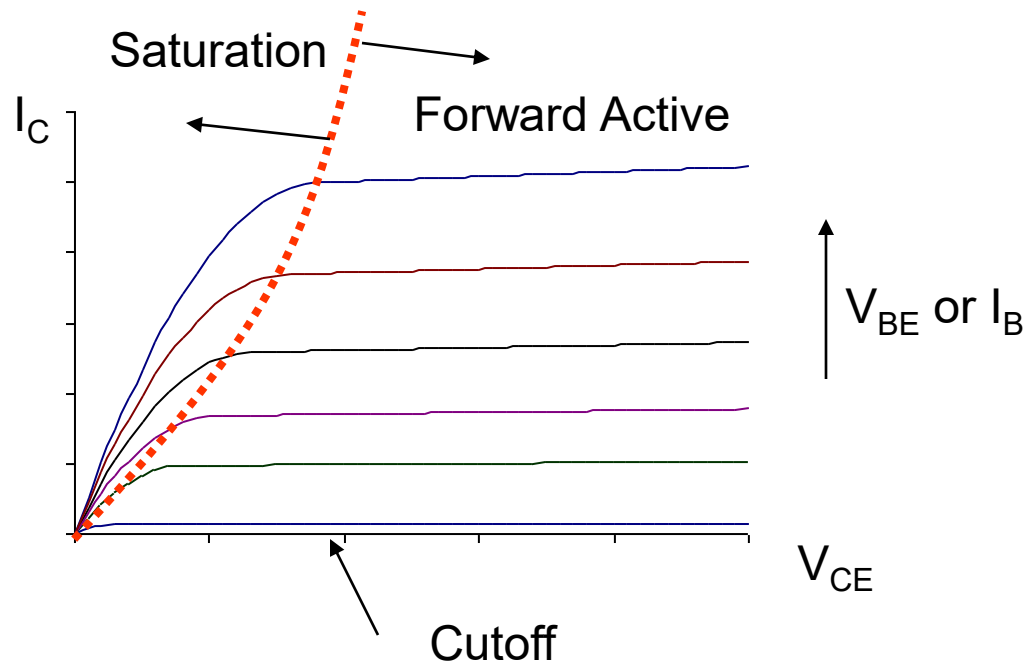

Forward Active region of BJT is analogous to Saturation region of MOSFET
Saturation region of BJT is analogous to Triode region of MOSFET



Stay Safe and Stay Healthy !

End of Lecture 19